



FastenMaster[®] PRO Driven

2025 PRODUCT GUIDE



25 Years of PRO Driven Innovation



TimberLOK
1998



TrapEase
2000



LedgerLOK
2006



Cortex
2008



MVP
2023



Fennell PRO

BIG GAME
ALASKA

CONCEALOC
GUN PANEL

Table of Contents

Deck & Trim Fastening

Cortex® Hidden Fastening System for Decking	7
Cortex® Hidden Fastening System for Fascia	8
Cortex® Hidden Fastening System for PVC Trim	9
Tiger Claw® Hidden Fastening Systems for Grooved Decking	11
TrapEase® 3 Ultimate Deck Screw for PVC, Capstock and Composites	13
TrapEase® 3 Fascia Color Matched Fascia Fastener	14
GuardDog® Exterior Wood Deck Screw	15
Deck Frame Coating	17

Structural Fasteners

TimberLOK® Structural Wood Screw	21
HeadLOK® Structural Wood Screw	23
LedgerLOK® and LedgerLOK® Flat Head Structural Wood Screw	25
FastenMaster VersaLOK™ Structural Wood Screw	27
FlatLOK® Structural Wood Screw	29
ThruLOK® Through-Bolt Replacement	31
FastenMaster MVP™ Multipurpose Wood Screw	33
Lateral Tension System® Code-Compliant Lateral Deck Attachment	35
OlyLog® & LogHog® Log Home Fasteners	37

Framing Systems

FrameFAST™ Structural Fastening System	41
NLB Connector™ For Non-Load Bearing Wall to Truss Connections	43
PAMFast™ AutoFeed Fastening System	45
PAMFast™ AutoFeed Screws	47

Product Ordering Information

.	49
-----------	----

At FastenMaster, Everything We Do Is PRO Driven

FastenMaster is committed to supporting our professional contractors' businesses by developing innovative products and services. Our wide range of products, including those for residential decking, structural fastening, remodeling, and wood framing, offer unique benefits to remodelers, professional deck builders, residential framers, and home builders. In addition, our nationwide sales team regularly collaborates on the jobsite with PROs to gain a comprehensive understanding of their business practices and product needs. This hands-on approach enables us to develop products that save time, reduce installation cost, and build to a high level of craftsmanship.



Improving PROs' Businesses Through Craftsmanship

At FastenMaster we know that having the strongest and most secure connections isn't enough. What separates the best PRO contractors is their attention to detail and creative solutions to complex problems. Throughout our history we have brought game changing technologies to our PROs that have given them more flexibility to be creative and deliver premium solutions to their customers. Whether it's designing a dynamic outdoor living space with Cortex hidden plugs and Tiger Claw hidden clips or framing an architectural showpiece with FrameFAST, FastenMaster will always be working alongside our PROs on their most difficult and unique projects.



Photo courtesy of Elite Decks



Photo courtesy Casey Fence & Deck

Improving PROs' Businesses Through Innovation

For the last 25 years FastenMaster, a division of OMG Inc., has worked side-by-side with top PRO contractors as we've developed the most innovative structural, decking and framing fastening solutions in the industry. Our American-based engineering and manufacturing teams have enabled us to develop cutting-edge fastening solutions that reduce installed cost, increase structural integrity and reflect a pride in craftsmanship. That's why thousands of top builders have made FastenMaster their preferred product, providing them with the confidence they need to take on any project.

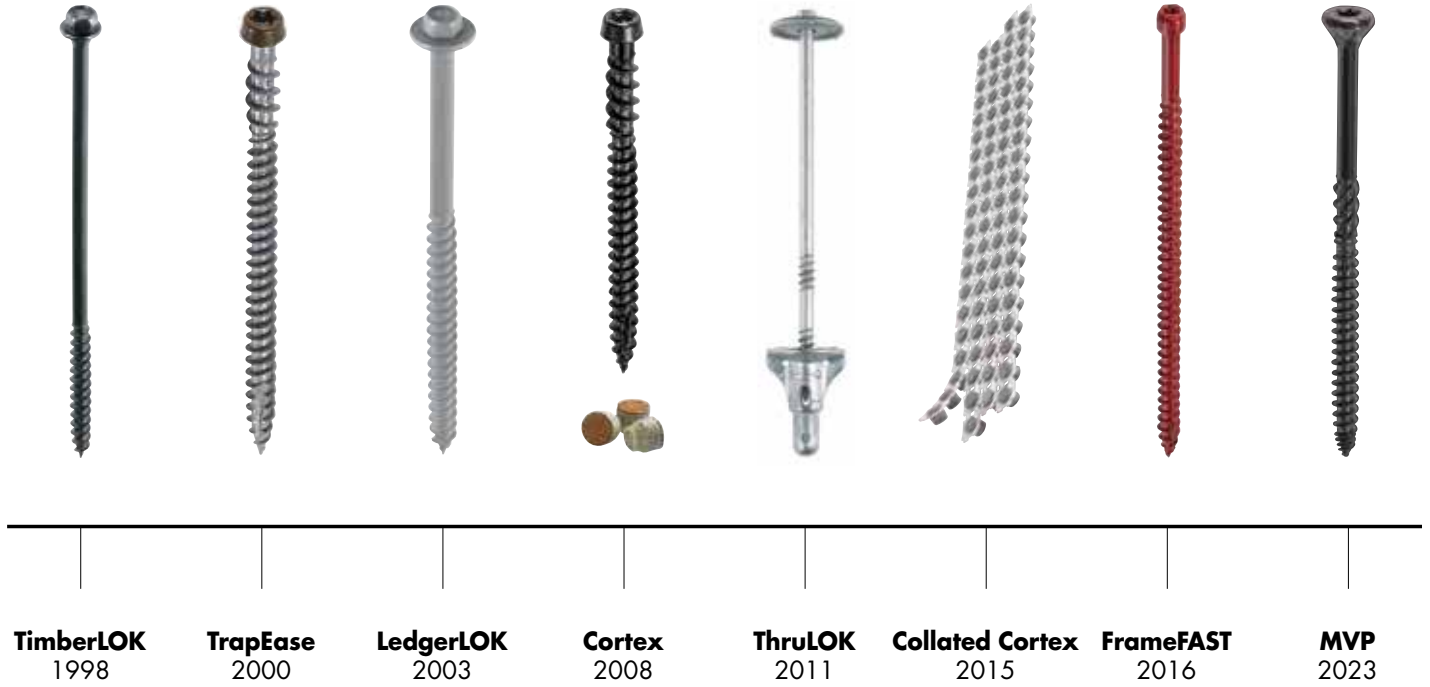

Improving PROs' Businesses Through American Manufacturing

Between our manufacturing facilities in Agawam, MA and Addison, IL, our logistics centers in Charlotte, NC and Glendale Heights, IL, and our nationwide sales organization, the entire team at FastenMaster is driven to improve our professional contractors' businesses. With over 650 team members specializing in everything from manufacturing and new product development to customer support and logistics, we have the knowledge and experience to deliver a uniquely American level of service and support. Whether you have a question for our technical team, are placing an order with our inside sales team, or training with your local sales representative, we are ready to provide the best experiences in the industry.



Deck & Trim Fastening

From strong substructures to a stunning finish, decking solutions that save time and deliver long-term results.



- 2000: The newly created composite decking industry ran into problems using traditional fasteners which would “mushroom” and damage the boards. We created the first fastener designed specifically for composite decking: TrapEase
- 2004: We developed GuardDog, the first exterior wood screw designed specifically to address the newer, more aggressive chemicals in pressure treated wood.
- 2006: The Tiger Claw TC-G Hidden Deck Clip launched as the industry’s first stainless steel hidden decking clip for grooved boards, bringing long-lasting quality and a nearly invisible finish.
- 2008: We created the first “through board” hidden fastening system with the introduction of Cortex plugs and screws, a game-changing innovation that gives PROs the ability to hide screws on a variety of applications including composite decking and PVC Trim. When combined with Tiger Claw TC-G, PROs could for the first time hide all the screws on the surface of a decking project.

Elevate Your Decking Craftsmanship

FastenMaster has spent decades listening to top PRO contractors as we've developed the most comprehensive deck and trim fastening solutions in the industry. We understand that craftsmanship requires the need to deliver superior quality with a flawless finished look. That's why thousands of premiere deck builders have made FastenMaster their preferred choice for delivering strong substructures with a stunning finish.

Cortex® Hidden Fastening System for Decking and Fascia	7
<ul style="list-style-type: none">• Now with pre-aligned grain plugs on collated strips• Plugs made from deck or fascia board for perfect match• TORX® tTap® drive system• Decking Screw Length: 2-1/2"• Fascia Screw Length: 1-3/4"• Metal Framing: 1-5/8"	
Cortex® Hidden Fastening System for PVC Trim	9
<ul style="list-style-type: none">• Collated strips install 50% faster• TORX® tTap® drive system• Lengths: 2", 2-3/4"	
Tiger Claw® TC-G® Hidden Fastening Systems for Grooved Decking	11
<ul style="list-style-type: none">• Quick and easy installation• Universal compatibility with grooved decking• Stainless steel for superior durability• Works with the Tiger Claw Pneumatic Installation Gun for even fastener installation	
TrapEase® 3 Ultimate Composite Deck and Fascia Fastener	13
<ul style="list-style-type: none">• Heads painted to match most popular board colors• TORX® tTap® drive system• Fascia fasteners engineered for fascia expansion/contraction• Deck Screw Lengths: 2-1/2", 3"• Fascia Screw Length: 1-3/4"	
GuardDog® Exterior Wood Deck Screw	15
<ul style="list-style-type: none">• Guaranteed corrosion resistance• UV resistant to fading and chalking• TORX® tTap® drive system• Lengths: 1-5/8", 2", 2-1/2", 3", 3-1/2"	
Deck Frame Coating	17
<ul style="list-style-type: none">• Extends life of the deck frame• Fast and clean application• Dries in as little as 20 minutes• Coats hard-to-reach places	





Close up of pre-aligned grain plug

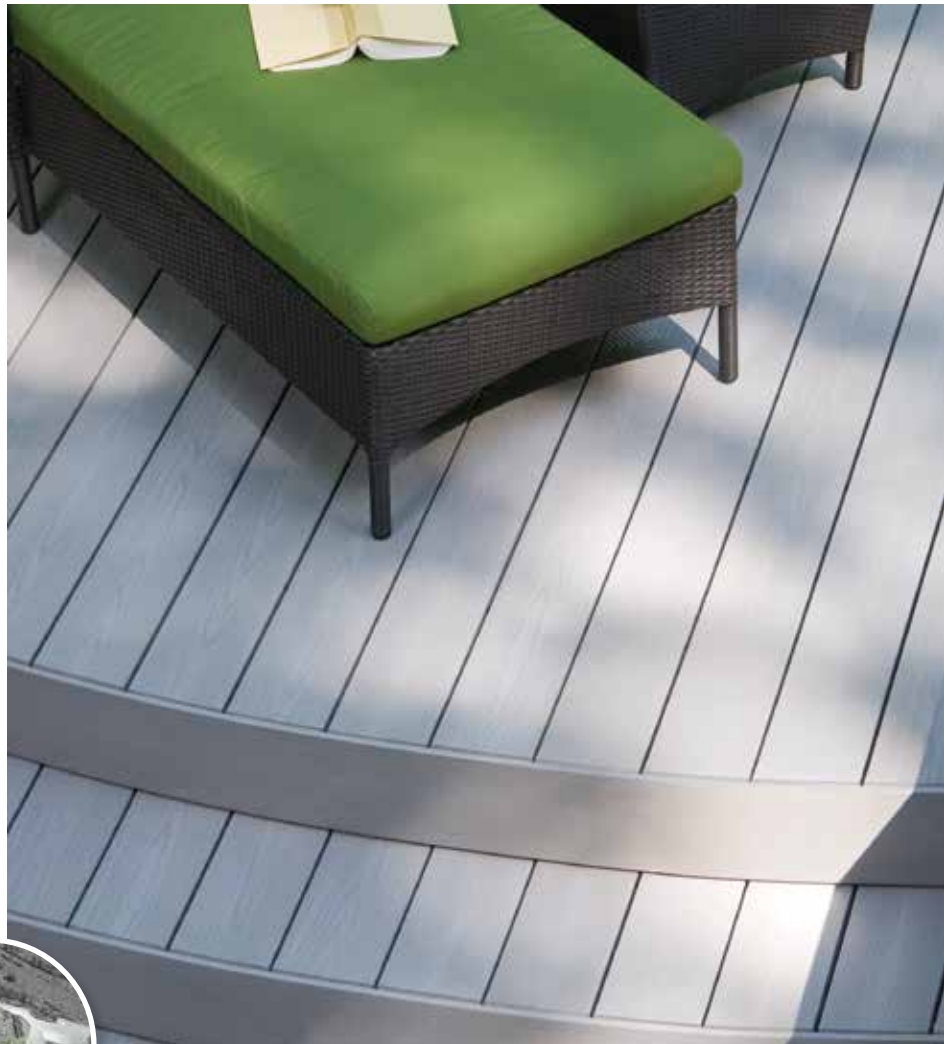

Cortex®

Hidden Fastening System For Decking

Features:

- Collated on strips with pre-aligned grain for faster and more precise installation
- Plugs made from specific deck boards for a perfect match
- Approved for treated wood framing
- Strip-out resistant #20 TORX® tTap® drive system

Packaging Quantities (Collated):

- 100 LF (224 screws, 240 plugs, 2 set. tools)
- 300 SF (1050 screws, 1200 plugs, 6 set. tools)

Length: 2-1/2"

Description:

The Cortex® Hidden Fastening System is the fastest, easiest way to hide the heads of your deck screws across the entire deck, first and last board, perimeter, and stairs. Cortex plugs are made from the same material as market-leading deck boards.

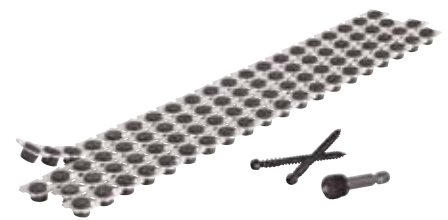

Complete Hidden Fastening System:

Combine the versatility of Cortex for first board, last board, perimeter boards and stairs with the speed and ease of the Tiger Claw TC-G Clip for the field of the deck to get a beautiful fastener-free surface.

ProjectLife™ Coating:

The performance and corrosion protection of Cortex is guaranteed for the life of the project.

Collated Cortex Decking Kits				
Screw Material	Board Type	Packaging Qty	Coverage	SKU
Carbon Steel	Trex Enhance®, Select®, Transcend®, Signature™, Transcend® Lineage™	224 screws, 240 plugs, 2 setting tools	100 LF	FMCTXCLTX1LF****
	Trex Select®, Transcend®, Signature™, Transcend® Lineage™	1050 screws, 1200 plugs, 6 setting tools	300 SQFT	FMCTXCLTX300****

**Selecting SKU/Board Color
When ordering, combine SKU column with deck color match guide on page 50.
Example: Trex Select 300 SQFT Saddle = FMCTXCLTX300SLSD

NEW Expanded Cortex Options

Stainless Steel Fasteners:

Cortex screws made with 316 marine grade stainless steel for coastal applications.

Driller Screws for Metal Framing:

1-5/8" 410 coated stainless steel screws designed for steel or aluminum deck framing.

Collated Cortex Plugs:

Collated Cortex plugs are now available for every Trex decking color in 400 piece boxes sold separate. See page 51 for SKU information.



Cortex® FASCIA

Hidden Fastening System



Features:

- Engineered for fascia expansion/contraction
- Plugs made from fascia board
- Strip-out resistant #20 TORX® tTap® drive system
- Perfect color match

Packaging Quantities:

50 LF (100 screws, 105 plugs,
1 counterbore tool and 1 setting tool)

Length: 1-3/4"



Cortex FASCIA Selection Guide				
Length	Board Type	Packaging Quantity	Coverage	SKU
1-3/4"	Trex Enhance®, Select®, Transcend®, Signature™, Transcend® Lineage™	100 screws, 105 plugs, 1 counterbore tool, 1 setting tool	50 LF	FMCTXF-TX50****

***Selecting SKU/Board Color
When ordering, combine SKU column with deck color match guide on page 50. Example: Trex Transcend Tiki Torch = FMCTXF-TX50TSTT



Close up of pre-aligned grain plug



Cortex®

Hidden Fastening System For PVC Trim

Features:

- Installs 50% faster with collated plugs
- Strip-out resistant #20 TORX® tTap® drive system
- Dual Lead Fastener Thread installs 50% faster than traditional trim fasteners

Lengths: 2", 2-3/4"

Packaging Quantities: (Loose Plugs)

- 50 LF (75 screws, 100 plugs, 1 set. tool)
- 250 LF (375 screws, 400 plugs, 3 set. tools)
- 750 LF (1125 screws, 1200 plugs, 6 set. tools)

Packaging Quantities: (Collated Plugs)

- 250 LF (375 screws, 400 plugs, 3 set. tools)
- 750 LF (1125 screws, 1200 plugs, 6 set. tools)

Description:

The FastenMaster Cortex® Hidden Fastening System is the fastest, easiest way to hide fastener heads when installing PVC Trim. The finished look of Cortex is virtually invisible.

ProjectLife™ Coating:

The performance and corrosion protection of Cortex Trim is guaranteed for the life of the project. Cortex Trim is not recommended for use in saltwater applications.

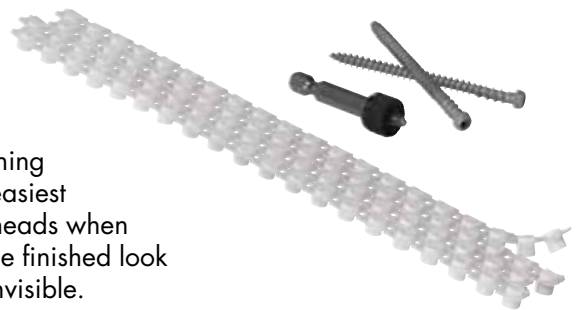

Cortex Trim Selection Guide						
Board	Color	Coverage	2" Fastener		2-3/4" Fastener	
			Loose Plugs	Collated Plugs	Loose Plugs	Collated Plugs
Versatex	SM = Smooth TR = Timber Ridge	50 LF	FMCTXT-VT50**	N/A	FMCTXT234-VT50**	N/A
		250 LF	FMCTXT-VT250**	FMCTXTCL-VT250**	FMCTXT234-VT250**	FMCTXTCL234-VT2**
		750 LF	FMCTXT-VT750**	FMCTXTCL-VT750**	FMCTXT234-VT750**	FMCTXTCL234-VT7**
Royal	SM = Smooth GN = Grain	50 LF	FMCTXT-RY50**	N/A	FMCTXT234-RY50**	N/A
		250 LF	FMCTXT-RY250**	FMCTXTCL-RY250**	FMCTXT234-RY250**	FMCTXTCL234-RY250**
		750 LF	FMCTXT-RY750**	FMCTXTCL-RY750**	FMCTXT234-RY750**	FMCTXTCL234-RY750**
Royal Select		250 LF	N/A	N/A	N/A	FMCTXTCL234-C2**
FT = Frost CN = Chestnut GV = Grove CL = Coastline MP = Imperial Red LT = Latte NA = Oceana WL = Willow CS = Castlestone TL = Timberland WR = Wrought Iron PB = Pine Brook SL = Shale RR = River Rock DP = Deep Pewter						
Boral	SM = Smooth GN = Grain	50 LF	FMCTXT-BR50TE**	N/A	FMCTXT234-BR50TE**	N/A
		250 LF	FMCTXT-BR250TE**	N/A	FMCTXT234-BR2TE**	N/A
		750 LF	FMCTXT-BR750TE**	N/A	FMCTXT234-BR7TE**	N/A
Cortex #20 TORX® ttap® driver bits (2 Pack of Setting Tools)						FMCTXSETTOOL3-2PK

**Selecting SKU/Board Color
 When ordering, please combine SKU column with board manufacturer color key.
 Example: Cortex 250 LF fastener length 2-3/4" for Versatex Smooth = FMCTXT234-VT250SM



Cortex Trim Replacement Plugs Selection Guide			
Board	Type	Description	SKU
Versatex®	Smooth	40pc collated replacement plugs	FMCTXTQUAD-VT40SM
	Timber Ridge		FMCTXTQUAD-VT40TR
Royal	Smooth	40pc collated replacement plugs	FMCTXTQUAD-RY40SM

New board colors are always being added to the Cortex product line. If the board color you are looking for is not listed on this page, consult our website for recent updates or call FastenMaster customer service.



FastenMaster offers perfectly matched Cortex Plugs for leading trim manufacturers including: AZEK®, CertainTeed®, KLEER®, Modern·Mill, Ply Gem®, Royal®, Versatex® and Wolf®. Plugs are made directly from the trim boards to ensure a perfect match every time!

See replacement plug information on page 52

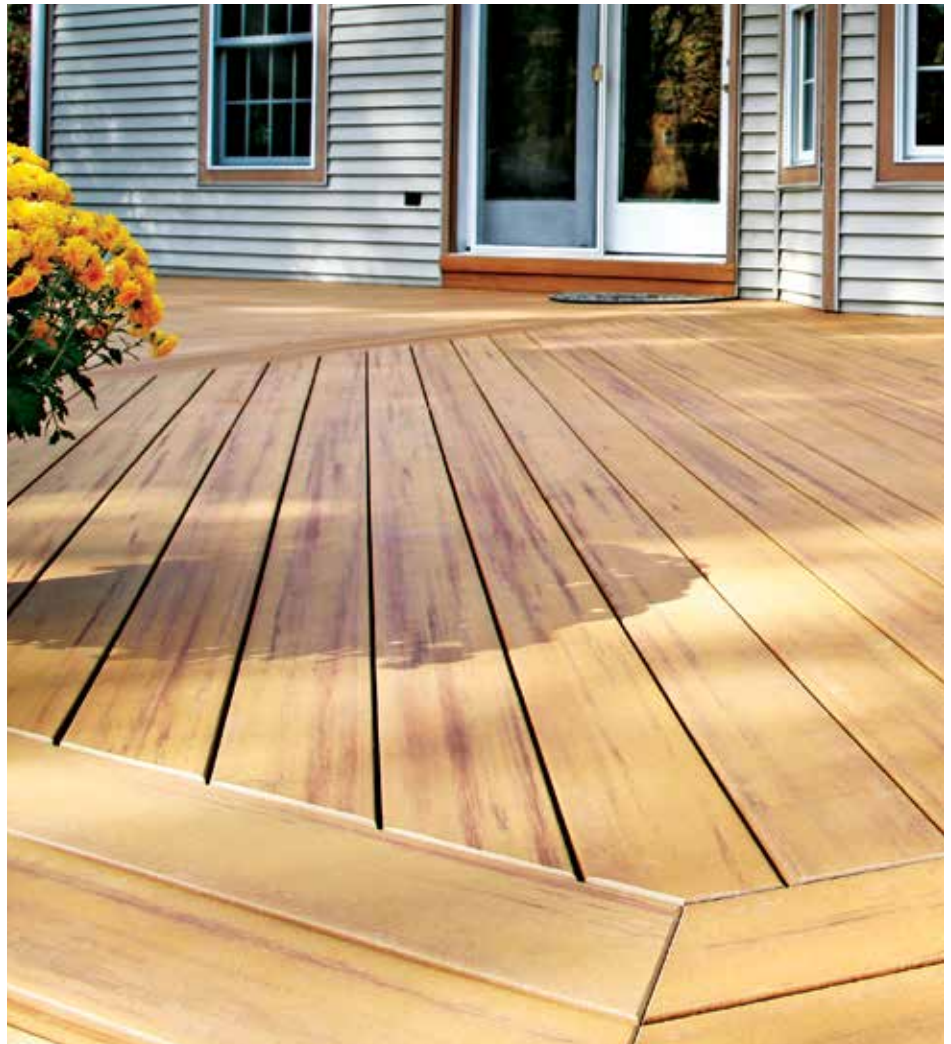

Tiger Claw[®]

Hidden Deck Fasteners

TC-G[®] and Installation Tools

Hidden Fastening Systems for Grooved Decking

Features:

- Automatically gaps decking
- Quick and easy installation
- Clean, fastener-free appearance
- Stainless steel for superior durability and ultimate corrosion resistance
- Strong connection between decking and joists

Packaging Quantities:

50 SF bag with hand driven screws (90 clips per bag) plus screws

500 SF bucket for use with pneumatic gun (900 clips per bucket)

Description:

This stainless steel hidden fastening system is designed to be universally compatible with all grooved decking boards. Delivers fast and easy installation, resulting in smooth, fastener-free outdoor living spaces.

Complete Hidden Fastening:

Combine the versatility of Cortex for first/last board, perimeter boards and stairs with Tiger Claw TC-G[®] for the field of the deck to get a beautiful fastener-free surface.



ProjectLife™ Guaranteed:

The performance and corrosion protection of TC-G is guaranteed for the life of the project. TC-G is not recommended for use in saltwater applications.

Tiger Claw Clips and Fasteners			
Description	Coverage	Length	SKU
Tiger Claw TC-G 90pc Bag (for hand driving clips)	50 SQFT	1-5/8"	F-4058-TCGS
Tiger Claw TC-G Bulk Gun Pail (scraill not included)*	500 SQFT	N/A	F-5913-GNFS
Tiger Claw Scraill - Carbon Steel*	500 SQFT	1-1/2"	F-5906-GNSC
Tiger Claw Scraill - Stainless Steel*	500 SQFT	1-1/2"	F-6557-SSPS
Tiger Claw Butt Seam Clips	30 SQFT	1-5/8"	F-5969-TCBC



Tiger Claw Pneumatic Installation Gun

Semi-automatic installation tool that greatly increases the installation speed of TC-G clips. This tool can also be used with TimberTech®, CONCEALoc™, Cali Bamboo®, Clubhouse™ and ConnectClip™ fasteners.



First Time User Program

FastenMaster offers PROs a FREE pneumatic installation gun for first time user with the purchase of a minimum of (2) gun pails of clips. Visit FastenMaster.com for information or scan QR code.

Collated Pneumatic Screws

For use with the pneumatic installation gun. Available in coated & stainless steel.



Scan to sign up



Butt Seam Clip

Stainless steel clip used in conjunction with TC-G. Allows for single joist butt seam installation.



Slot Cutter

Creates a perfect groove for clips in square edge Trex® decking boards.



Tiger Claw Clip Installation Tools	
Description	SKU
Installation Gun for use with F-5906-GNSC and F-6557-SSPS pneumatic scraills	F-5899-IGUN
TC-G Slot Cutter specifically designed to cut grooves into square edge decking	R-5206-RB3W



PVC

Capstock

Composite



TrapEase® 3

Ultimate Deck Screw for PVC, Capstock & Composites

Features:

- For PVC, capstock and composite decking
- Strip-out resistant #20 TORX® ttap® drive system
- Head painted to match board
- Corrosion and fade resistant
- Spotter™ Installation Guide creates consistent board gapping and fastener placement (available only on 350pc bucket)

Lengths: 2-1/2", 3"

Packaging Quantities:

75pc box, 350pc bucket, 1,050pc bucket

Description:

TrapEase® 3 is the only fastener guaranteed to deliver an ultimate finished look in PVC, Capstock, and Composite decking. The TORX® ttap® drive system offers stick-fit and wobble-free installation, virtually eliminating fastener stripping during installation or removal. TrapEase 3 features a UV resistant head paint that will not fade for the life of the project – guaranteed.

ProjectLife™ Coating:

The performance and corrosion protection of TrapEase 3 is guaranteed for the life of the project. TrapEase 3 is not recommended for use in saltwater applications.



TrapEase 3					
Length	Material	Quantity	Description	Coverage	SKU
2-1/2"	Carbon Steel	75pc box	75 screws, 1 bit	20 SQFT	FMTR3-212-75****
		350pc bucket	350 screws, 3 bits	100 SQFT	FMTR3-212-350****
		1050pc bucket	1050 screws, 6 bits	300 SQFT	FMTR3-212-1050****
	316 Stainless Steel	350pc bucket	Light Gray (LGSS) Light Brown (LBSS)	Dark Gray (DGSS) Dark Brown (DBSS)	FMTR3-212-350****



***Selecting SKU/Board Color
When ordering, combine SKU column with deck color match guide on page 50.
Example: Trex Select 350pc Pebble = FMTR3-212-350SLPB

3" also available for Trex Select® 350pc and 1050pc in: SLMD, SLPB, SLSD, SLVB



Scan to find your match

FastenMaster offers color matched screws for many of the industry leading board manufacturers. See a complete listing of color offerings on page 50 or scan the code above.

TrapEase® FASCIA

Color Matched Fascia Fastener



Features:

- Engineered for fascia expansion and contraction
- Head painted to color match fascia board
- Strip-out resistant #20 TORX® itap® drive system
- Corrosion and fade resistant

Length: 1-3/4"

Packaging Quantity:

Complete with 200 screws, 1 counterbore tool, and 1 driver bit

Description:

The strongest, fastest way to attach composite fascia. Designed to allow for Fascia board expansion and contraction, delivering beautiful finished look.



TrapEase FASCIA Selection Guide			
Screw Length	Packaging Qty	Coverage	SKU
1-3/4"	200 Screws, 1 Counterbore Tool, 1 Driver Bit	100 LF	FMTRF-1LF**

**Selecting SKU/Board Color
When ordering, combine SKU column with deck color match guide on page 50.
Example: Trex Transcend, Rope Swing = FMTRF-1LFRS





GuardDog® Exterior Wood Screw

Features:

- TORX® tTap® Drive System delivers stick fit, wobble free installation
- Sharp Type 17 Point for quick installation
- UV Resistant to fading or chalking
- Guaranteed Corrosion resistance for the life of the project
- Nibs under the head deliver a clean finished look

Lengths: 1-5/8", 2", 2-1/2", 3", 3-1/2"

Packaging Quantities:

75pc box, 350pc box, 1,750pc bucket, 1,350pc bucket (3-1/2" only)

Description:

GuardDog® is a versatile exterior wood screw used for a variety of applications including pressure treated decking, railings, deck framing and more.

TORX® tTap® Drive System

The TORX® tTap® drive system offers unmatched stick-fit and wobble-free installation, eliminating fastener stripping during installation or removal.



GuardDog Selection Guide			
Screw Length	Packaging Qty	Coverage	SKU
1-5/8"	75pc box	20 SF	FMGD158-75
	350pc box	100 SF	FMGD158-350
	1,750pc bucket	500 SF	FMGD158-1750
2"	75pc box	20 SF	FMGD002-75
	350pc box	100 SF	FMGD002-350
	1,750pc bucket	500 SF	FMGD002-1750
2-1/2"	75pc box	20 SF	FMGD212-75
	350pc box	100 SF	FMGD212-350
	1,750pc bucket	500 SF	FMGD212-1750
3"	75pc box	20 SF	FMGD003-75
	350pc box	100 SF	FMGD003-350
	1,750pc bucket	500 SF	FMGD003-1750
3-1/2"	75pc box	20 SF	FMGD312-75
	350pc box	100 SF	FMGD312-350
	1,350pc bucket	350 SF	FMGD312-1350
Driver bit for GuardDog w/ TORX ttap drive system (2 included)			FMGDTTAPT25-2PK



Guaranteed Corrosion Resistance:

The performance and corrosion protection of GuardDog is guaranteed for the life of the project. Approved for use in exterior applications including treated wood (ACQ, MCA, MCQ, CAB) and acidic woods like cedar and redwood. GuardDog is not recommended for use in saltwater applications.

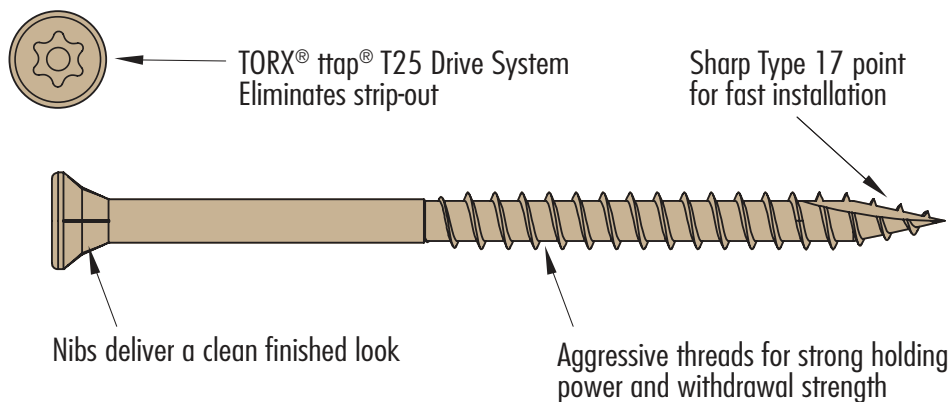



Deck Frame Coating

Protective Waterproofing Coating

Features:

- Extends life of the deck frame.
Creates a lasting moisture barrier protection
- Fast and clean application.
No mess coverage with less jobsite waste
- Dries in as little as 20 minutes.
Sets fast for deck board installation
- Coats hard-to-reach places.
Use in corners tape cannot reach

Packaging Quantities:

1 gallon bucket

Extend the Life of Your Deck Frame!

FastenMaster Deck Frame Coating extends the life of your deck substructure by creating a protective moisture barrier that deters wood rot and decay on deck joists, beams, ledgers, stair stringers and posts.



Deck Frame Coating Selection Guide

Description	Coverage	SKU
1 gallon bucket	450 LF	FMDFC-1GAL

For a full written warranty, additional engineering data and technical support visit FastenMaster.com.

*Approximate coverage per gallon at 20mil or .5mm dry film thickness

**High temperature and / or high humidity may extend set time.



Application:

FastenMaster's Deck Frame Coating can be applied using a standard bristle paint brush or a heavy duty, 3/8" nap roller. It is recommended to apply a generous and consistent single layer of coating.

- Apply in temperatures above 40 °F / 4 °C. Freeze/thaw stable when cured.
- Product is in a liquid state, protect from freezing. If product was frozen, allow 12 hours of thaw time before use.
- Fast dry formula sets in as little as 20 minutes.**
- Full cure in 24 hours @ 70°F/21°C and 50% humidity.**
- Do not apply to dirty/contaminated or wet surfaces.
- Coating remains slightly tacky when cured.

Clean Up:

Clean skin or building materials using soap & warm water. Mineral Oil or Baby Oil can be used. It is recommended to review the decking manufacturer's warranty before using cleaners.

Caution:

Keep out of reach of children & pets. Wear gloves, eye protection and avoid contact with clothing. If in eyes, flush with water for several minutes. Get medical attention if irritation persists. If swallowed call a poison center or doctor for advice. Low VOC waterproofing sealer contains <100g/L VOC.

**Extend the life of your deck frame
by creating a lasting moisture
barrier in all critical areas!**



**See how
quick and easy
it is to apply**



For use on the following applications



Deck Joists



Stair Stringers



Deck Carrying Beams



Deck Posts

Structural Fasteners

The industry-leading LOK Line replaces traditional lag screws while meeting code and lowering cost.

1998: FastenMaster created the category of structural wood-to-wood screws with the introduction of TimberLOK.

2003: FastenMaster launched LedgerLOK, the first fastener specifically designed to replace 1/2" lag screws, without predrilling, when attaching a ledger board to a rim joist of a house. It was also the very first structural screw to gain code compliance under the newly adopted ICC-ES criteria.

2004: We launched TrussLOK (later replaced by FlatLOK in 2015) the first fastener to connect multiple beams of LVL single sided up to 4 -ply.

2007: Taking the most loved elements of the best-selling TimberLOK, we created the industry's first flat headed structural fastener to meet code: HeadLOK.

2011: ThruLOK was the first fastener to replace carriage and through-bolts without predrilling. ThruLOK makes the connection 5X faster and eliminates multiple tools on the job to install.

We Invented The Structural Wood Screw. We Didn't Stop There.

In the two decades since FastenMaster created the structural wood screw category with TimberLOK, we have continued to lead the industry by providing innovative, application-specific fasteners that meet building code and help PROs finish jobs faster. It is our mission to improve our PRO contractors' businesses with code-compliant products by actively participating at their jobsites, understanding their problems, and developing products that deliver job-specific results.

TimberLOK® Structural Wood Screw	21
<ul style="list-style-type: none"> • Replaces 3/8" lag screws · Hex head drive • Lengths: 2-7/8", 4-1/2", 6", 8", 10" 	
HeadLOK® Structural Wood Screw	23
<ul style="list-style-type: none"> • Replaces 3/8" lag screws · Flat head with SpiderDrive • Standard Lengths: 2-7/8", 4-1/2", 6", 8", 10" 	
LedgerLOK® and LedgerLOK® FlatHead Structural Wood Screw	25
<ul style="list-style-type: none"> • Replaces 1/2" lag screws · Hex head or TORX® ttap® drive system • Lengths: 3-5/8", 5" 	
FastenMaster VersaLOK™ Structural Wood Screw	27
<ul style="list-style-type: none"> • Replaces 1/2" lag screws · TORX® ttap® drive system • Lengths: 6", 8", 10" 	
FlatLOK® Structural Wood Screw	29
<ul style="list-style-type: none"> • Replaces 1/2" lag screws · TORX® ttap® drive system • Lengths: 2-7/8", 3-1/2", 4", 4-1/2", 5", 6", 6-3/4" 	
ThruLOK® Through-Bolt Replacement	31
<ul style="list-style-type: none"> • Replaces 1/2" carriage or through-bolts · Hex head drive • Lengths: 6-1/4", 7", 8", 9-1/2" 	
FastenMaster MVP™ Multipurpose Wood Screw	33
<ul style="list-style-type: none"> • ProjectLife™ Coating · SureStart™ Point · TORX® ttap® drive system • Lengths: 1-1/2", 2", 2-1/2", 3", 3-1/2", 4" 	
Lateral Tension System® Lateral Deck Attachment	35
OlyLog® & LogHog® Log Home Structural Wood Screws	37





TimberLOK®

Structural Wood Screw



Features:

- No predrilling
- Faster and easier than 3/8" lag screws
- Countersinking head style
- ProjectLife™ Guaranteed
- Approved in treated wood
- Code-Compliant Evaluation Report ICC-ES ESR-1078

Lengths: 2-1/2", 4", 6", 8", 10"

Packaging Quantities:

Single fastener, 12pc clamshell, 50pc box, 250pc bucket, 500pc bucket (2-1/2" only)

Description:

TimberLOK® is a heavy duty wood screw suitable for a wide variety of structural wood-to-wood applications such as headers, stair stringers, fences and more. TimberLOK requires no predrilling and is faster and easier than traditional lag screws.

Meet Code. Lower Cost.

TimberLOK is used by professional contractors nationwide to meet code and lower costs. *Meet Code:* Tested and proven to meet the most recent IRC/IBC requirements. *Lower Cost:* Requires no predrilling, saving time and labor.

TimberLOK Selection Guide			
Length	Typical Applications	Packaging Qty	SKU
2-1/2"	Doubling/sistering up 2x header or carrying beams	Single fastener	FMTLOK212-INDY
		12pc clamshell	FMTLOK212-12
		50pc box	FMTLOK212-50
		500pc bucket	FMTLOK212-500
4"	Attaching 2x to 4x structures - fencing	Single fastener	FMTLOK04-INDY
		12pc clamshell	FMTLOK04-12
		50pc box	FMTLOK04-50
		250pc bucket	FMTLOK04-250
6"	Replacing hurricane ties on rafters or trusses. Joining multiple 4x timbers	Single fastener	FMTLOK04-INDY
		12pc clamshell	FMTLOK06-12
		50pc box	FMTLOK06-50
		250pc bucket	FMTLOK06-250
8"	Building up 6x landscape walls	Single fastener	FMTLOK08-INDY
		12pc clamshell	FMTLOK08-12
		50pc box	FMTLOK08-50A
		250pc bucket	FMTLOK08-250
10"	Post and Beam construction	Single fastener	FMTLOK10-INDY
		12pc clamshell	FMTLOK10-12
		50pc box	FMTLOK10-50A
		250pc box	FMTLOK10-250



Installation Procedure:

TimberLOK should be installed using an impact driver or quality grade cordless drill (18V or greater). Choose the proper length so that threads fully engage the second piece. Bring washer head flush to wood surface or countersink head flush.

ProjectLife™ Guaranteed:

The performance and corrosion protection of TimberLOK is guaranteed for the life of the project. TimberLOK is not recommended for use in saltwater applications.

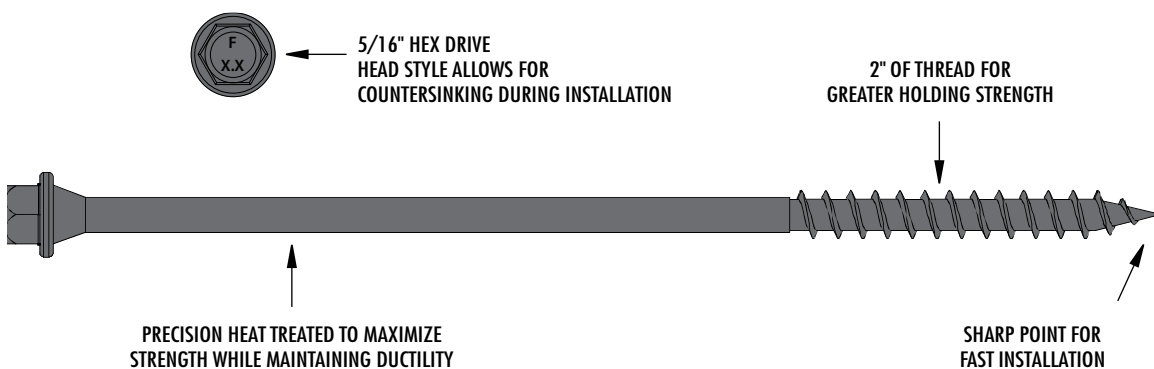



HeadLOK® Structural Wood Screw

Features

- TORX® tTap® Drive System delivers superior bit engagement for a stable wobble-free installation
- ProjectLife™ Coating with superior corrosion protection guaranteed for the life of the project
- Code-Compliant, tested and supported by engineering data that conforms to ICC-ES ESR-1078

Lengths: 2-7/8", 4-1/2", 6", 8", 10"
additional sizes also available

Packaging Quantities:

Single fastener, 12pc clamshell, 50pc box, 250pc bucket, 500pc bucket (2-7/8" only)

NEW TORX® tTap®



Description

HeadLOK® is a heavy duty wood screw that does it all with an internal drive, flat head and now with a TORX® tTap® drive system. HeadLOK offers higher design shear than 3/8" lag screws with no predrilling. HeadLOK is ideal for many wood-to-wood applications including decks, fences, SIPs, kitchen cabinets and more. The patented TORX® tTap® drive system eliminates cam-out and improves installation speed.

Meet Code. Lower Cost.

HeadLOK is used by professional contractors nationwide to meet code and lower costs. *Meet Code:* Tested and proven to meet the most recent IRC/IBC requirements. *Lower Cost:* Requires no predrilling, saving time and labor.

HeadLOK Standard Selection Guide		
Length	Packaging Qty	SKU
2-7/8"	Single fastener	FMHLGMT278-INDY
	12pc clamshell	FMHLGMT278-12
	50pc box	FMHLGMT278-50
	500pc bucket	FMHLGMT278-500
4-1/2"	Single fastener	FMHLGMT412-INDY
	12pc clamshell	FMHLGMT412-12
	50pc box	FMHLGMT412-50
	250pc bucket	FMHLGMT412-250
6"	Single fastener	FMHLGMT006-INDY
	12pc clamshell	FMHLGMT006-12
	50pc box	FMHLGMT006-50
	250pc bucket	FMHLGMT006-250
8"	Single fastener	FMHLGMT008-INDY
	12pc clamshell	FMHLGMT008-12
	50pc box	FMHLGMT008-50
	250pc bucket	FMHLGMT008-250
10"	Single fastener	FMHLGMT010-INDY
	12pc clamshell	FMHLGMT010-12
	50pc box	FMHLGMT010-50
	250pc bucket	FMHLGMT010-250

Additional Length Selection Guide		
Length	Packaging Qty	SKU
3-3/4"	50pc bucket	FMHLGMT334-50
	250pc bucket	FMHLGMT334-250
5"	250pc bucket	FMHLGMT005-250
7"	250pc bucket	FMHLGMT007-250
8"	250pc bucket	FMHLGMT008-250
9"	250pc bucket	FMHLGMT009-250
10"	250pc bucket	FMHLGMT010-250
11"	250pc bucket	FMHLGMT011-250
12"	250pc bucket	FMHLGMT012-250
13"	250pc bucket	FMHLGMT013-250
14"	250pc bucket	FMHLGMT014-250

HeadLOK TORX ttap Bits	
2 TORX® ttap® bits per card	FMTTAPT30BIT-2PK



ProjectLife™ Coating:

The performance and corrosion protection of HeadLOK is guaranteed for the life of the project. HeadLOK is not recommended for use in saltwater applications.

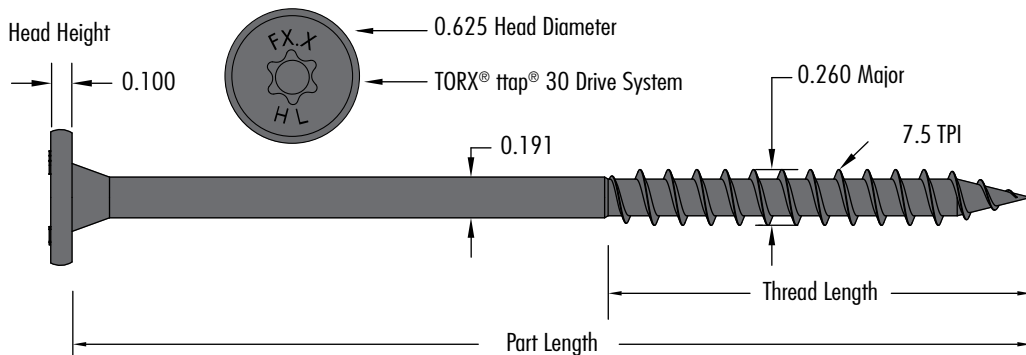



FLAT HEAD STYLE



HEX HEAD STYLE



LedgerLOK®

Structural Wood Screw



Features:

- No predrilling
- Replaces traditional 1/2" lag screws
- Hex washer head style on LedgerLOK
- TORX® ttap® Drive System on Flat Head style
- ProjectLife™ Coating
- Approved for treated wood
- Code-Compliant Evaluation Report ICC-ES ESR-1078

Lengths: 3-5/8", 5"

Packaging Quantities:

Single fastener, 12pc clamshell, 50pc box, 250pc bucket

Description:

LedgerLOK® are the first wood screws engineered to fasten a deck ledger board to the rim joist of a house with no predrilling. The hex-head version allows for greater bit engagement, reducing cam-out. The flat head version, with TORX® ttap® drive system, provides flush to ledger installation saving time and money.

Meet Code. Lower Cost.

LedgerLOKs are used by professional contractors nationwide to meet code and lower costs for making deck ledger connections. *Meet Code:* Tested and proven to meet the most recent IRC/IBC requirements for deck ledger to rim joist connection. *Lower Cost:* Requires no predrilling, saving time and labor.



LedgerLOK Selection Guide			
Length	Packaging Qty	Hex Style SKU	Flat Head SKU
3-5/8"	Single Fastener	FMLL358-INDY	FMLLF358-INDY
	12pc clamshell	FMLL358-12	FMLLF358-12
	50pc box	FMLL358-50	FMLLF358-50
	250pc bucket	FMLL358B-250	FMLLF358B-250
5"	Single Fastener	FMLL005-INDY	FMLLF005-INDY
	12pc clamshell	FMLL005-12	FMLLF005-12
	50pc box	FMLL005-50	FMLLF005-50
	250pc bucket	FMLL005B-250	FMLLF005B-250



Installation Procedure:

LedgerLOKs should be installed using an Impact driver or a high torque 1/2" variable speed drill. Choose the proper length so that threads fully engage the main member (i.e., rim joist). Bring washer flush to side member with hex head style, do not countersink. Bring head flush with ledger using the flat head style. *Not for use in masonry or concrete.*

For detailed installation instructions, including fastening requirements, please refer to our *Deck Ledger to Rim Joist technical bulletin*. These instructions are included in all box and bucket packaging as well as being available for download from our website. When using in non-ledger applications, a design professional should be consulted for all critical connections, which include the number and location of all fasteners to meet national and local code requirements.

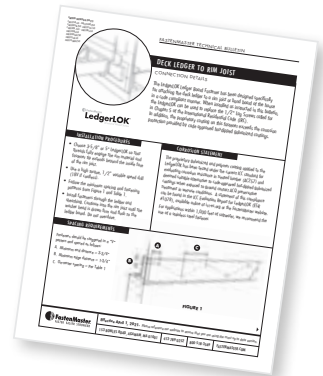

ProjectLife™ Coating:

The performance and corrosion protection of LedgerLOK is guaranteed for the life of the project. LedgerLOK is not recommended for use in saltwater applications.

Flat Head Style

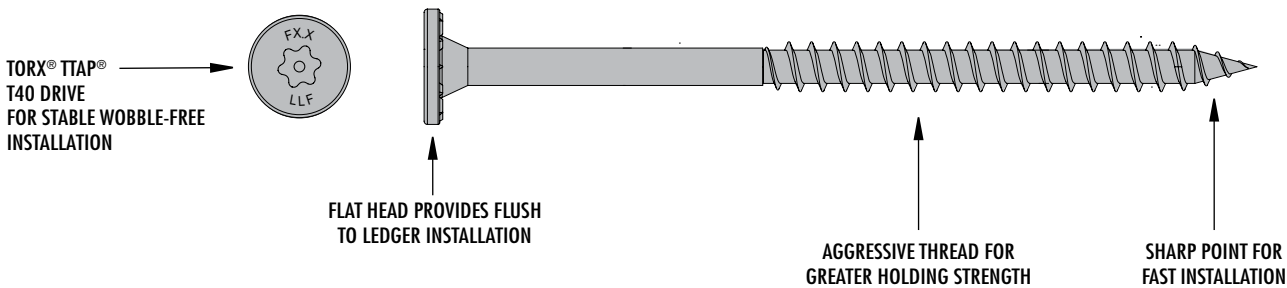

Hex Head Style

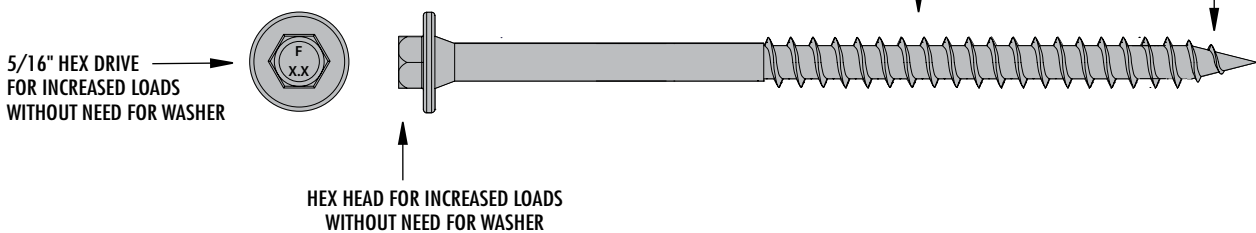



FastenMaster VersaLOK™

Structural Wood Screw



Features:

- No Predrilling
- Faster and easier than 1/2" Lags
- Attractive flush mount flat head
- ProjectLife™ Coating
- Approved for treated lumber
- IBC/IRC Code-Compliant ESR-1078
- TORX® itap® drive system

Lengths: 6", 8", 10"

Packaging Quantities:

Single fastener, 50pc box

Description:

FastenMaster VersaLOK™ is a heavy-duty wood screw that can be used in a wide variety of structural applications. The performance and corrosion resistance of the VersaLOK fastener is guaranteed for the life of the project when used in accordance with the installation instructions and supporting technical literature.

Meet Code. Lower Cost.

Meet Code: VersaLOK has been tested and proven to meet the most recent IBC/IRC requirements.

Lower Cost: Requires no predrilling, saving time and labor.

VersaLOK Screw SKU Selection Guide		
Length	Pkg Qty	SKU
6"	Single Fastener	FMVLO06-INDY
	50pc box	FMVLO06-50
8"	Single Fastener	FMVLO08-INDY
	50pc box	FMVLO08-50
10"	Single Fastener	FMVLO10-INDY
	50pc box	FMVLO10-50



Installation Procedure:

VersaLOK should be installed using an impact driver or high torque 1/2" variable speed drill (minimum 18V if cordless). Choose the proper length fastener so that the threads fully engage the innermost member being attached. Bring the washer head flush to the surface. Not for use in concrete or masonry.

ProjectLife™ Coating:

The performance and corrosion protection of VersaLOK is guaranteed for the life of the project. VersaLOK is not recommended for use in saltwater applications.

Flat Head With TORX® ttap® Drive:

The flat head installs flush, saving additional time and money. Plus, gain stronger bit engagement with the TORX® ttap® drive system.

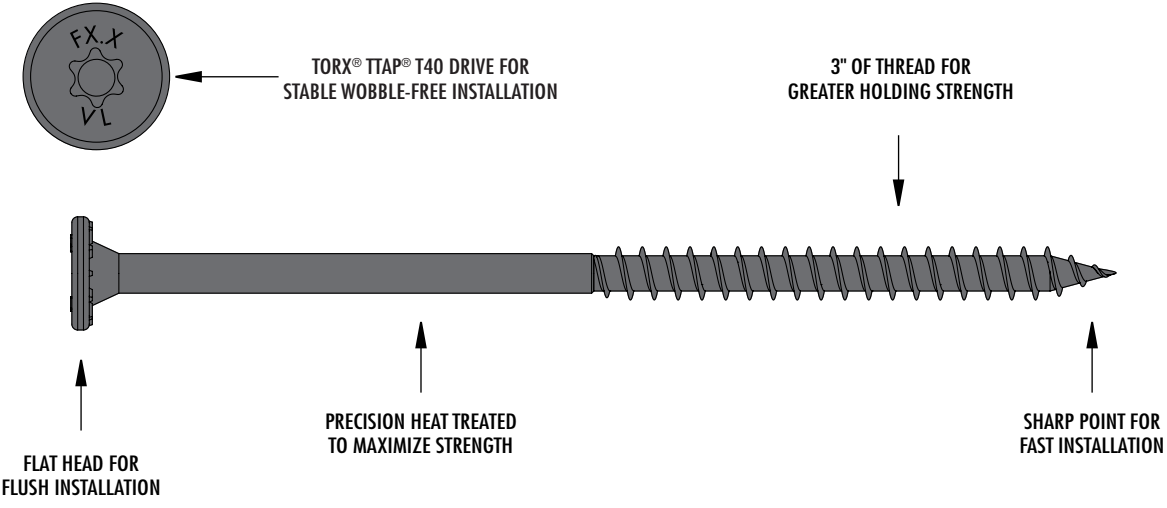



FlatLOK® Structural Wood Screw

Features

- No predrilling
- #40 TORX® tTap® drive system
- ProjectLife™ Coating
- Approved for single-sided installation
- Code-Compliant Evaluation Report ICC-ES AC233

Lengths: 2-7/8", 3-1/2", 4", 4-1/2", 5", 6", 6-3/4"

Packaging Quantities:

Single fastener, 50pc box, 250pc bucket, 500pc bucket (2-7/8" only), 200pc bucket (6-3/4" only)



Description

FlatLOK® is designed for various multi-ply dimensional and engineered wood connections. FlatLOK is approved for single-sided installation. Not intended for use on exterior deck ledgers; FastenMaster LedgerLOK is designed specifically for that application.

Meet Code. Lower Cost.

FlatLOK delivers strong, code-compliant connection for multi-ply LVL, girder trusses and multi-ply lumber beams.

Meet Code: Tested to meet manufacturers, requirements for single-sided installation of multi-ply LVL, LSL and PSL.

Lower Cost: Requires no predrilling, saving time and labor.



FlatLOK Selection Guide			
Length	Typical Applications	Packaging Qty	SKU
2-7/8"	2-Ply Roof Girder Trusses	50pc box	FMFL278-50
		500pc bucket	FMFL278B-500
3-1/2"	2-Ply LVL Beams	Single fastener	FMFL312-INDY
		50pc box	FMFL312-50
		250pc bucket	FMFL312B-250
4"	Interior Corridor Ledgers	50pc box	FMFLO04-50
		250pc bucket	FMFLO04B-250
4-1/2"	3-Ply Roof Girder Trusses	50pc box	FMFL412-50
		250pc bucket	FMFL412B-250
5"	3-Ply LVL Beams	Single fastener	FMFLO05-INDY
		50pc box	FMFLO05-50
		250pc bucket	FMFLO05B-250
6"	4-Ply Roof Girder Trusses	50pc box	FMFLO06-50
		250pc bucket	FMFLO06B-250
6-3/4"	4-Ply LVL Beams	Single fastener	FMFL634-INDY
		50pc box	FMFL634-50
		200pc bucket	FMFL634B-200



Installation Procedure:

FlatLOK should be installed using an impact driver or high torque 1/2" variable speed drill (minimum 18V if cordless). No predrilling is required when properly installed. Bring fastener flush with wood surface, do not overdrive.

ProjectLife™ Guaranteed:

The performance and corrosion protection of FlatLOK is guaranteed for the life of the project. FlatLOK is not recommended for use in saltwater applications.

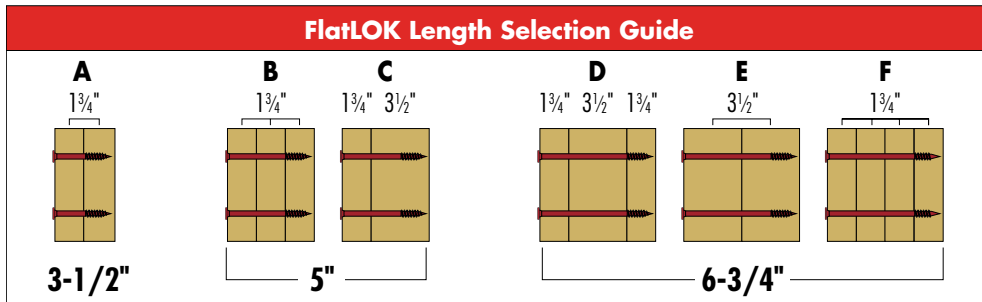

Footnotes

- Fasteners should be installed in a staggered pattern at least 1-3/4" from top or bottom edge and 3-3/4" from either end of the beam

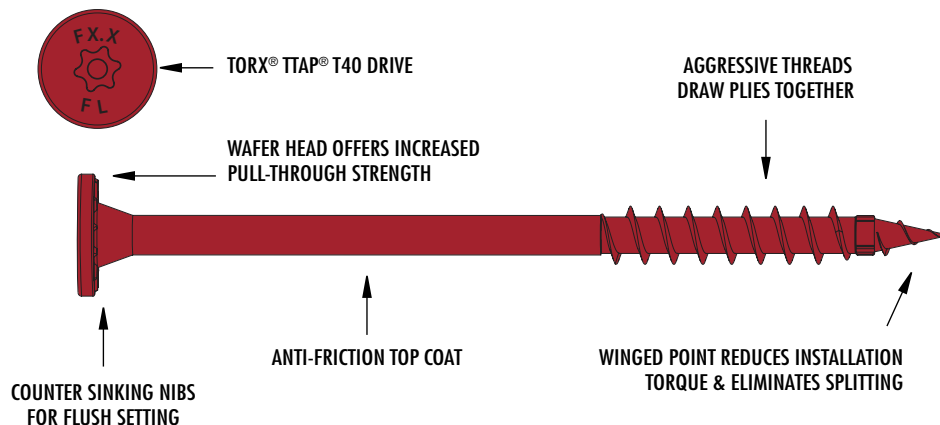



ThruLOK[®]

Through-Bolt Replacement



Features:

- No predrilling
- Faster, easier than 1/2" through-bolts
- No drill bits or wrenches required
- Galvanized coating meets code requirements for treated wood
- Code-Compliant Evaluation Report ICC-ES ESR-1078

Lengths: 6-1/4", 7", 8", 9-1/2"

Packaging Quantities:

Single fastener, 24pc box

Description:

The ThruLOK[®] System combines the strength of a through-bolted connection with the speed of a FastenMaster LOK fastener.

- 6-1/4": engineered to connect 4x4 posts to 2x joists
- 7": engineered to connect two 2x beams to a notched 6x6 post
- 8": engineered to connect 4x4 posts to a double rim joist or single rim joist and 2x blocking.
- 9-1/2": engineered to attach a 6x6 post two 2x beams

Meet Code. Lower Cost.

Meet Code: ThruLOK has been tested to meet the most recent IBC/IRC requirements for guard post to rim joist connections.
Lower Cost: Requires no predrilling, saving time and labor.



ThruLOK Screw Selection Guide			
Length	Wood Dim Range	Pkg Qty	SKU
6-1/4"	4-1/2" to 5-1/4"	Single Fastener	FMTHR614-INDY
		24pc box	FMTHR614-24
7"	5-1/4" to 6"	Single Fastener	FMTHR007-INDY
		24pc box	FMTHR007-24
8"	6-1/4" to 7"	Single Fastener	FMTHR008-INDY
		24pc box	FMTHR008-24
9-1/2"	7-3/4" to 8-1/2"	Single Fastener	FMTHR912-INDY



Installation Procedure:

No predrilling required when properly installed. Put the ThruLOK washer on the screw with the teeth of the washer facing away from the head of the fastener. Using a 1/2" high torque variable speed drill (18V if cordless), drive the ThruLOK until washer and hex-head are just above the wood surface (approx. 1/4") and point of screw protrudes out other side of connection. Thread the nut onto point of fastener. Tighten nut until flush with wood. Tighten screw with drill. *NOTE: Point of fastener must engage in nut to "MIN" line or beyond.*

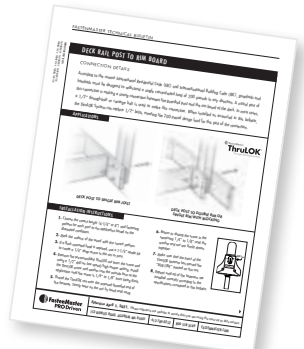

For detailed installation instructions, including fastening requirements, please refer to our *ThruLOK Deck Post and Carrying Beam technical bulletins*. These instructions are included in all packaging as well as being available for download from our website. A design professional should be consulted for all other critical connections, to include the number and location of all fasteners to meet national and local code requirements.

ProjectLife™ Guaranteed:

The performance and corrosion protection of ThruLOK is guaranteed for the life of the project. ThruLOK is not recommended for use in saltwater applications.

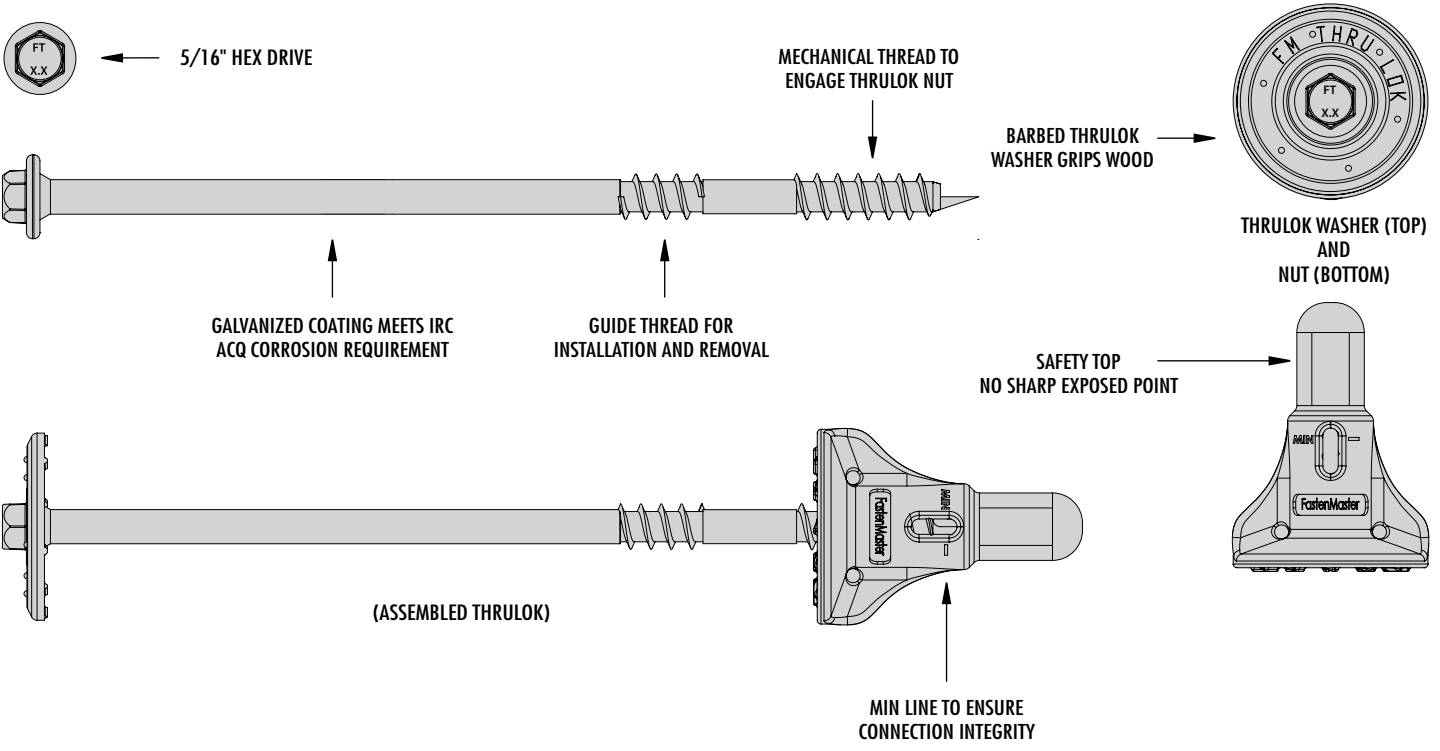



FastenMaster MVP™

Multipurpose Wood Screw



Features:

- TORX® ttap® drive system wobble-free drive
- SureStart™ Point for fast starts
- ProjectLife™ Coating with superior corrosion protection
- SureSink™ Head prevents spin-out
- For Framing, Cabinetry & More

Lengths: 1-1/2", 2", 2-1/2", 3", 3-1/2", 4"

Packaging Quantities:

100pc box, 250pc bucket, 500pc bucket, 1250pc bucket, 1600pc bucket, 2000pc bucket

Description:

The FastenMaster MVP™ Multipurpose Wood Screw has been designed for increased connection strength, durability, and corrosion resistance. The MVP fastener is IRC/IBC code-compliant and supported by an ICC-ES Evaluation Report ICC-ES ESR-5265 that can be found at FastenMaster.com.

The FastenMaster MVP delivers a best in category drive system coupled with superior corrosion protection. ProjectLife Guaranteed.

FastenMaster MVP Selection Guide		
Length	Packaging Qty	SKU
1-1/2"	100 Pack	FMMVP112-100
	500 Pack	FMMVP112-500
	2000 Pack	FMMVP112-2000
2"	100 Pack	FMMVP002-100
	500 Pack	FMMVP002-500
	2000 Pack	FMMVP002-2000
2-1/2"	100 Pack	FMMVP212-100
	450 Pack	FMMVP212-450
	2000 Pack	FMMVP212-2000
3"	100 Pack	FMMVP003-100
	350 Pack	FMMVP003-350
	1600 Pack	FMMVP003-1600
3-1/2"	100 Pack	FMMVP312-100
	250 Pack	FMMVP312-250
	1250 Pack	FMMVP312-1250
4"	100 Pack	FMMVP004-100
	250 Pack	FMMVP004-250
	1250 Pack	FMMVP004-1250



ProjectLife™ Coating:

The performance and corrosion protection of FastenMaster MVP is guaranteed for the life of the project. Approved for use in exterior applications including treated wood (ACQ, MCA, MCQ, CAB). FastenMaster MVP is not recommended for use in saltwater applications.

FastenMaster MVP Features:

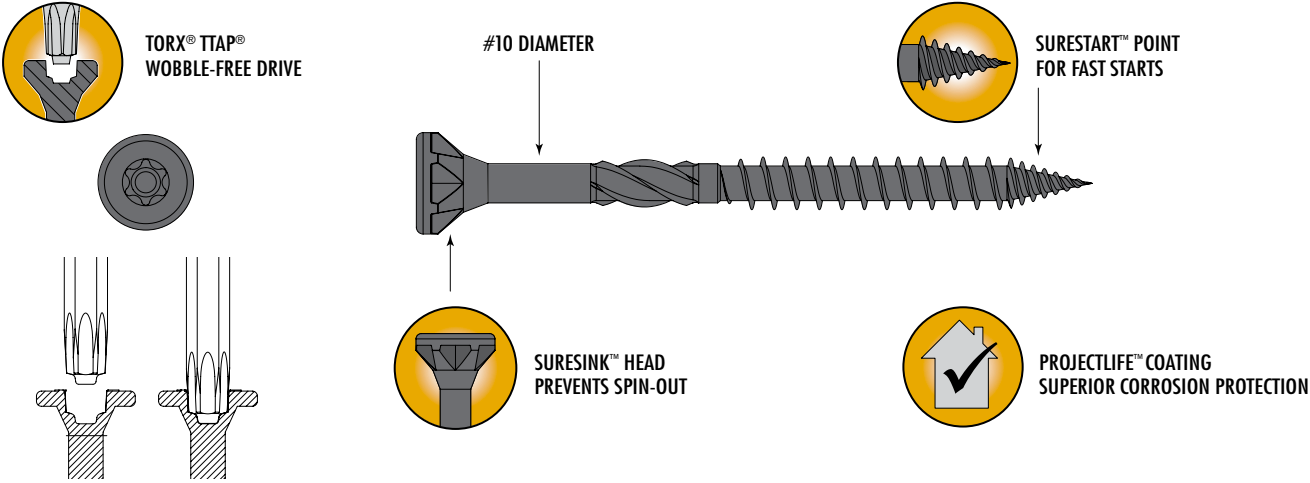



Lateral Tension System™

Code Compliant Lateral Deck Attachment



Features:

- Meets IRC lateral load requirements for decks
- Guaranteed galvanized
- No pre-drilling required
- No interior access needed to install
- Free bits in every package

Packaging Quantities:

Each kit contains:

- (4) Lateral Tension Brackets
- (4) Transfer Screws
- (32) Bracket Mounting Screws
- (2) Driver Bits

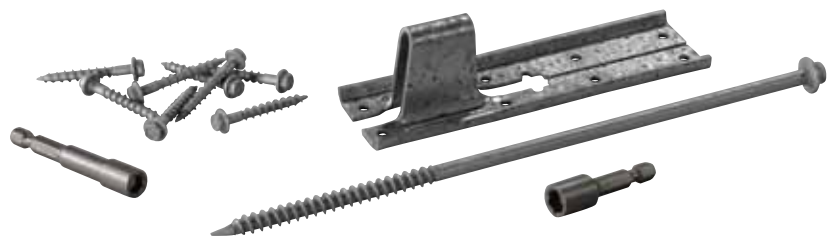

Description:

Lateral Tension System™ (LTS) is a complete kit designed to meet the newest code for transferring lateral deck loads. The International Residential Code (IRC) requires that decks be designed to withstand 750 pounds of lateral load in four locations along the ledger. LTS allows for attachment from the deck joist then directly to an interior sill plate, wall plate or stud – all from the outside.

Lateral Tension System Selection Guide

Contents	SKU
(4) Lateral Tension Brackets, (4) Transfer Screws, (32) Bracket Mounting Screws, (2) Driver Bits	FMLTS-4

Installation Procedure:

The LTS is approved for the five most common installation conditions:

- Condition A:** Sill Plate or Wall Plate Behind Ledger
- Condition B:** Sill Plate or Wall Plate Directly Below Ledger
- Condition C:** Sill Plate or Wall Plate 2" – 5" below Ledger
- Condition D:** Wall Stud in line with Deck Joist
- Condition E:** Wall Stud between Deck Joists



The FastenMaster LTS, is one complete kit to make all five of these code conforming connections. Each LTS bracket attaches an individual deck joist to a structural framing member of the house. With the LTS, you can install the fastener first and then add the bracket. The long fastener allows you to achieve the 3" of threading within the sill plate without having to access the interior of the house. You can achieve the code complaint connection in seconds.

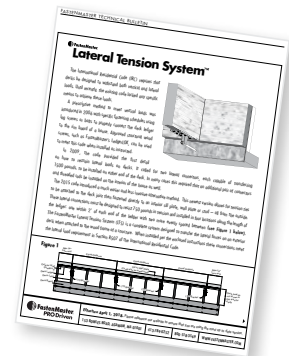

ProjectLife™ Guaranteed:

The performance and corrosion protection of LTS is guaranteed for the life of the project. LTS is not recommended for use in saltwater applications.

Tension Transfer Screw

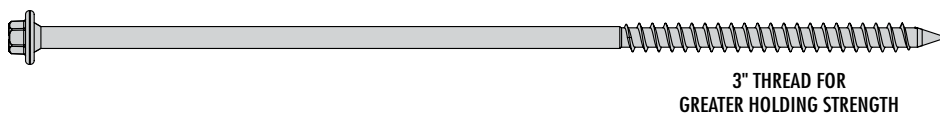

Bracket Mounting Screw

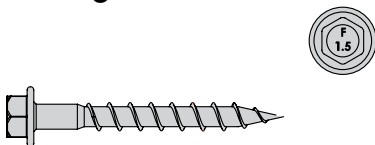

LTS Bracket Top View

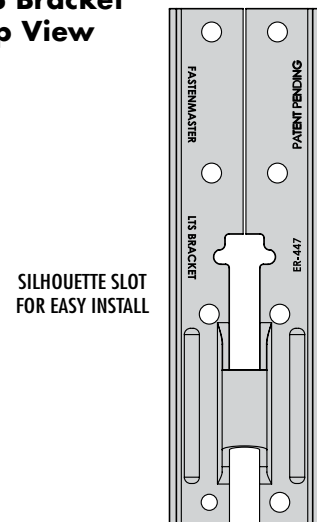

LTS Bracket Profile

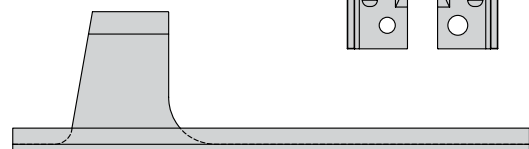

OlyLog®

Log Home Fastener



Features:

- Installs faster and easier than lags and spikes
- No predrilling
- Draws warped logs down
- Removable and reusable
- Eliminates jarring and damage caused by a sledgehammer
- ProjectLife™ guaranteed

Description:

OlyLog® is the original threaded log home fastener that requires no predrilling.

Installation Procedure:

Use a 1/2", high torque, low RPM drill.
Install OlyLog perpendicular to the log.
Countersink minimum of 1/4".

Lengths: 2-1/2", 4", 6", 8", 9", 10", 12", 14", 16"

Packaging Quantities:

250pc box, 500pc box (2-1/2" only)



OlyLog SKU Selection Guide

Length	Packaging Qty	SKU
2-1/2"	500pc box	LOG212
4"	250pc box	LOG004
6"	250pc box	LOG006
8"	250pc box	LOG008
9"	250pc box	LOG009
10"	250pc box	LOG010
12"	250pc box	LOG012
14"	250pc box	LOG014
16"	250pc box	LOG016



LogHog®

Heavy Duty Log Home Fastener

Features:

- Installs much faster and easier than lags and spikes
- Countersinks into log — allows log to settle naturally
- No predrilling
- Removable and reusable
- Eliminates jarring and damage caused by sledgehammers
- ProjectLife™ guaranteed

Description:

LogHog® is an extra heavy-duty log home fastener, engineered for specific log home construction applications. The LogHog, with its oversized head, thicker diameter and additional thread, offers increased draw-down and holding power. This fastener is corrosion resistant guaranteed.

Installation Procedure:

Use a 1/2", high torque, low RPM drill. Install LogHog perpendicular to the log. Countersink minimum of 1/4".

Lengths: 7", 9", 10", 11", 12", 13", 15"

Packaging Quantities:

150pc box (15" only), 250pc box



LogHog SKU Selection Guide

Length	Packaging Qty	SKU
7"	250pc box	LHOG007
9"	250pc box	LHOG009
10"	250pc box	LHOG010
11"	250pc box	LHOG011
12"	250pc box	LHOG012
13"	250pc box	LHOG013
15"	150pc box	LHOG015

Framing Systems

Drive productivity with tools and fasteners that make new construction more safe and efficient.



2016: FrameFAST was the first fastener and tool system specially designed to replace clips and strapping when attaching rafter tail to top plate and other critical building connections.

2019: FastenMaster created the NLB (Non-Load Bearing) Connector which was the first faster approved to replace top mounted clips when attaching non load bearing walls to resist lateral movement. NLB is the only fastener that can be installed from underneath without predrilling and comes with a unique friction-free sleeve that allows for vertical movement.

Frame Faster, Safer, and Easier with FastenMaster Framing Systems

For over twenty years, FastenMaster has delivered innovative structural wood-to-wood fastening solutions that increase installation speed and safety. We're driven by a relentless commitment to the professional builder. This PRO Driven focus is why FastenMaster is a trusted brand of framing contractors and structural design engineers. FastenMaster Framing Systems are designed to drive job site productivity by making new construction safer and more efficient.

FrameFAST™ Structural Framing System	41
• Installs 5x faster than traditional connectors	
• Available in corded and cordless power options	
• Increases safety by eliminating ladders	
NLB Connector™ for Non-Load Bearing Walls	43
• Installs 8x faster than channel brackets	
• Accommodates up to 1-1/2" gap at the top of non-load bearing walls	
• No predrilling	
PAMFast™ AutoFeed Fastening System	45
• 2-in-1 whole home fastening solution	
• Available in corded and cordless power options	
• Extensive offering of fastener varieties enables <i>PAMFast</i> to drive screws anywhere you do	
PAMFast™ AutoFeed Screws	47
• PAMFast Fasteners: Featuring PAMDrive 6-lobe recess for improved bit life and fewer cam-outs	
• Drives productivity on the job site: faster installation and ergonomic, ease of use benefits	
• PAMMax fastener belt holds up to 40% more fasteners so workers spend more time driving screws and less time reloading	





FrameFAST™

Structural Framing System

Features:

- 5x Faster: Code approved connections are made in a fraction of the time versus installing a hurricane clip.
- Easy to Install: Featuring a TORX® ttap® drive and free alignment guide included in every package.
- ProjectLife™ Guarantee: Performance and corrosion protection is guaranteed for the life of the project.
- Approved for use in exterior applications including pressure treated wood(ACQ). Not recommended for use in saltwater applications.



The FrameFAST Fastener:

FrameFAST™ replaces common hurricane ties and is installed without the need for compressors, nailers, and hoses. The updated FrameFAST Fastener empowers PROs with the choice of using a standard impact driver or the award winning FrameFAST Tool.

Lengths: 6"

Packaging Quantities:

50pc box, 250pc bucket



FrameFAST Fastener		
Description	SKU	Package Contains
FrameFAST with TORX® ttap® 50 piece box	FMFFTT006-50	(50) fasteners (1) alignment guide (1) TORX® ttap® driver bit - 2"
FrameFAST with TORX® ttap® 250 piece box	FMFFTT006B-250	(250) fasteners (1) alignment guide (1) TORX® ttap® driver bit - 2" (1) TORX® ttap® driver bit - 6"



TORX® ttap®
drive system

5" of thread for greater
holding strength

Sharper point for
faster installation

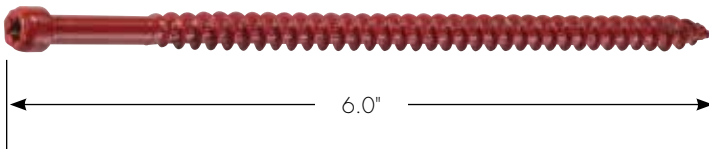

FrameFAST Tools:

- Maximize safety and productivity with the FrameFAST installation tool.
- Make code compliant connections without the use of a ladder.
- 3 interchangeable heads ensure consistent installation of the fastener in a variety of continuous load path applications.
- Fully assembled tools complete with cordless drivers by Milwaukee and DeWALT
- Scan the QR code for more information and to see FrameFAST tool in action.



**LEARN MORE
ABOUT FRAMEFAST**

FrameFAST Installation Tools	
Description	SKU
FF Cordless DeWALT	FMFFTOOL-T2TP-DWC
FF Cordless Milwaukee	FMFFTOOL-T2TP-MILC

Additional Installation Heads	
Description	SKU
Truss-to-Top-Plate Head	FMFFHEAD-T2TP
Stud-to-Plate Head	FMFFHEAD-S2P
Plate-to-Rim Head	FMFFHEAD-P2R





NLB Connector™

For Non-Load Bearing Wall to Truss Connections



Features:

- No predrilling
- Installs 8x faster than channel brackets
- Allows up to 1-1/2" gap between the top of non-load bearing walls and trusses / joists above
- Free drive/set tool in every package

Lengths: 6"

Packaging Quantities:

50pc box

Description:

The NLB Connector™ is the fastest and easiest way to secure the top of non-load bearing walls to trusses and joists above. This code-compliant connection allows for vertical deflection of the bearing members above, without transferring load into the interior partition walls below.

The NLB Connector accommodates up to a 1-1/2" gap between the top of the wall and the bearing member above. This enables framers to use the same precut stud lengths as the bearing walls, and because there is no need to predrill, it's twice as fast as other non-load bearing wall connectors on the market.

NLB Selection Guide	
Description	SKU
NLB Connector (50 pack)	FMNLB006-50



Installation Procedure

1. Attach the NLB Setting Tool w/Driver bit to an 18" driver bit extension pole (not included).
2. Insert the head of the NLB Connector into the magnetic driver bit.
3. Confirm connection locations based on plan drawings or refer to the Allowable Lateral Load Pounds per Connection table below.
4. Position the NLB Connector below the top plate of the wall such that it will drive through the wall plate and upward into the intersecting framing member above.
5. On the highest drill speed setting, drive directly upward through the wall plate and into the truss/joist above until the fastener automatically disengages from the driver bit.



Allowable Lateral Load per Connection based on Plate Configuration and Gap Between Top Plate and Framing

	Single Top Plate					Double Top Plate	
	0"	1/4"	1/2"	3/4"	1-1/2"	3/4"	1-1/2"
Max. Gap	0"	1/4"	1/2"	3/4"	1-1/2"	3/4"	1-1/2"
Load (lbs)	275	240	210	175	115	175	115

- Minimum thread embedment of 1/2" into wood truss with minimum size 1-1/2" x 3-1/2"
- In 0" gap condition, truss or wood structural member must bear on top plate of partition wall
- Load duration factor of 1.6 applied for short term wind loads. No further increase allowed
- NLB Connectors can be used on wood I-joist where EVW manufacturer's recommendations to predrill or add blocking are followed

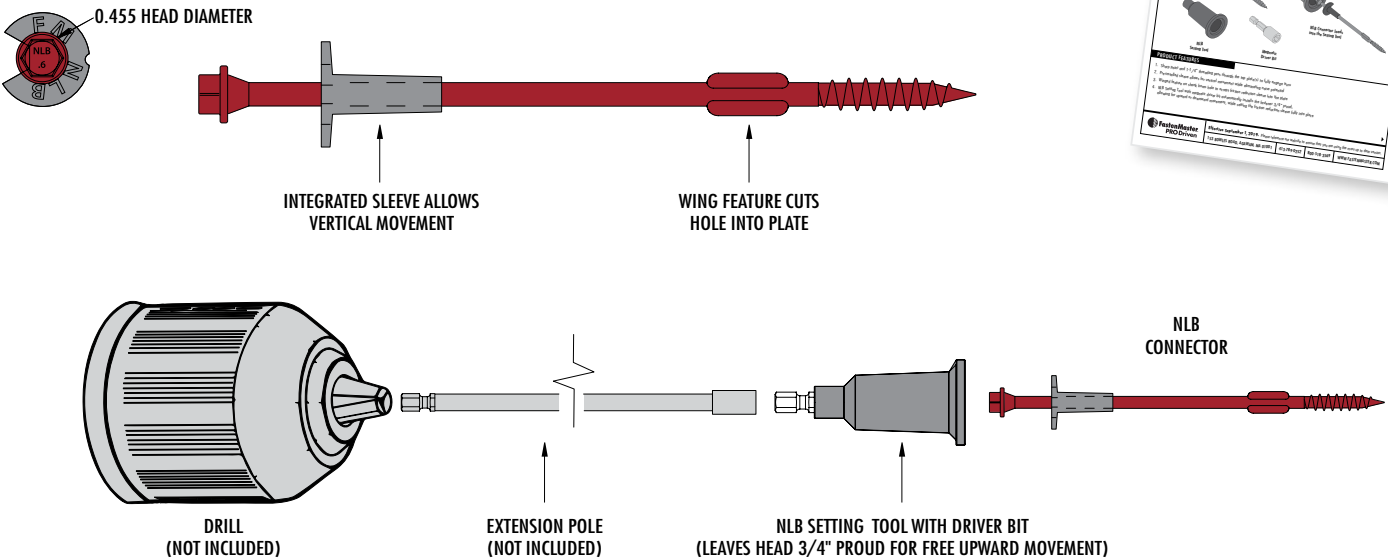
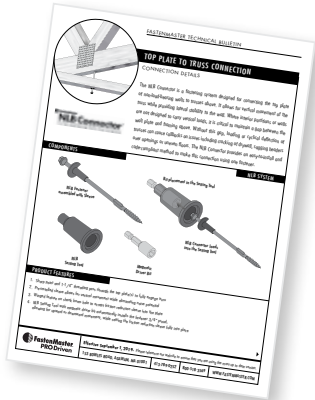



PAMFast™ Autofeed Fastening System

Features:

- 2-in-1 interchangeable length tool is a versatile whole home fastening system
- Smooth Advancement Technology delivers consistent fastening with no jams
- PAMMax fastener belt holds up to 40% more fasteners so workers spend more time driving screws and less time reloading
- Fasten subfloor and decking while standing comfortably or convert to a short tool for drywall, roof tiles, and more
- Fully assembled tools come complete with cordless screw guns by DeWALT and Makita



Description:

The smoothest, most versatile PRO grade screw delivery system is now available with cordless power. *PAMFast* tools come fully assembled with high power screw guns from DeWALT, Makita, or Milwaukee, or choose a kit that is specially engineered to fit your drill. All *PAMFast* tools include long/ short conversion pieces and are compatible with all genuine *PAMFast* collated screws.

SKU	Compatible Motor	Power Type
SD-20-DWC13KUE*	DeWALT DCF622B	Cordless
SD-20-MAC13KUE*	Makita XSF04Z	Cordless
SD-20-DW13KUE	DeWALT DW268	Corded
SD-20-DWC13KIT**	DeWALT DCF622B	Cordless
D-20-MAC13KIT**	Makita XSF04Z	Cordless

*Batteries/charger sold separate **Kit only (no screw gun)



The Whole Home Fastening Solution!

PAMFast is a 2-in-1 interchangeable length tool. The removable extension pole enables easy long-to-short conversion for a variety of fastening needs. Fasten subfloor and decking while standing comfortably, or convert to a short tool to fasten drywall, roof tiles, and more.



AutoFeed Gun Features:

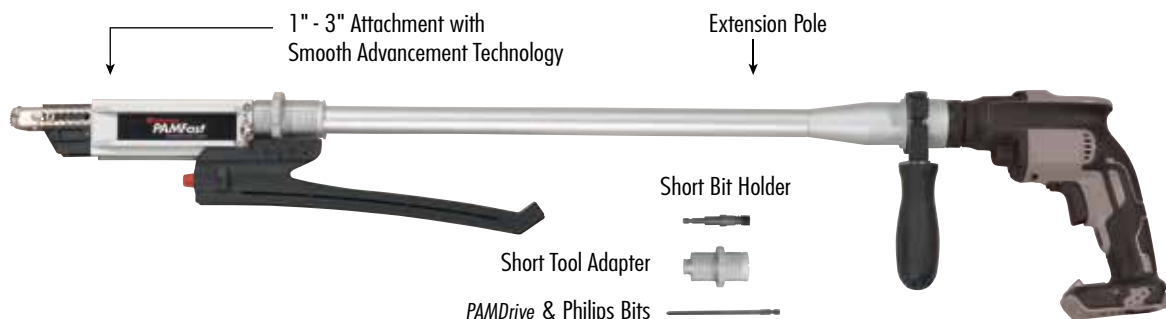



PAMFast™

Autofeed Screws

Features:

- PAMFast Fasteners: Featuring PAMDrive 6-lobe recess for improved bit life and fewer cam-outs
- Drives productivity on the job site: faster installation and ergonomic, ease of use benefits
- PAMMax fastener belt holds up to 40% more fasteners so workers spend more time driving screws and less time reloading

Packaging Quantities:

50 screws per strip, 1,000 screws per box

Interior Wood Screws

✦ Wood to Wood Subfloor PAMDrive, 3/8 Coarse Fast Thread, Yellow Zinc, X-point



#8 x 1 1/4"	flat head	WCYZ8114
#8 x 1 1/2"	flat head	WCYZ8112
#8 x 1 3/4"	flat head	WCYZ8134F
#8 x 2"	flat head	WCYZ8200F
#8 x 2 1/2"	flat head	WCYZ8212F
#8 x 3"	flat head	WCYZ8300F

✦ High Density Wood (Advantech®) to Wood PAMDrive, Full Coarse Thread, Yellow Zinc, X-Point



#8 x 1 3/4"	flat head	FDYZ8134
#8 x 2"	flat head	FDYZ8200

✦ Wood to Wood Underlayment #2 Philips Drive, Hi-Lo Thread, Black Phosphate



#7 x 1"	modified trim head with nibs	**MTH7100
#7 x 1 1/4"	modified trim head with nibs	MTH7114

Cement Fiber Board/Siding to Wood

- ✦ **Cement Fiberboard/Siding to Wood**
 ✓ACQ **PAMDrive, Coarse Thread,**
 Copperhead External Grade Coating



#8 x 1 3/4" modified wafer head with flutes MWMC8114
 #8 x 1 5/8" modified wafer head with flutes MWMC8158

Exterior Decking Screws

- ✦ **Pressure Treated Decking to Wood**
 ✓ACQ **PAMDrive, 2/3 Coarse Thread, Type 17 or X-Point,**
 Stainless Steel or Copperhead External Grade Coating



#8 x 1 3/4" flat head WDCH8134
 #8 x 2" flat head WDCH8200
 #8 x 2 1/2" flat head WDCH8212
 #8 x 3" flat head WDCH8300



#8 x 2 1/2" trim head **THCH8212



#10 x 3" flat head - 316 SS **WDSS1003

- ✦ **TrapEase 3 Collated Screws Composite Decking to Wood**



#8 x 2 1/2" brown FMAFTR3-212-1000BR
 #8 x 2 1/2" gray FMAFTR3-212-1000GY
 #8 x 2 1/2" dark brown FMAFTR3-212-1000DB

Drywall to Wood Screws

- ✦ **Drywall to Wood**
#2 Phillips Drive, Coarse Thread, Black Phosphate



#6 x 1 1/4" bugle head GCBP6114
 #6 x 1 5/8" bugle head GCBP6158
 #7 x 2" bugle head GCBP7200
 #8 x 2 1/2" bugle head GCBP8212

Roof Tile Screws

- ✦ **Roofing Tile to Wood**
 ✓ACQ **PAMDrive, 2/3 Coarse Thread, Stainless Steel or**
 Copperhead. **Miami Dade Co Certification #L 09-0720.14**



#8 x 2 1/2" flat head WTDC8212
 #8 x 2 1/2" flat head (Darco Coating) WDDC8212



#8 x 2 1/2" bugle head **WDSB8212

Drywall to Steel Screws

- ✦ **Drywall to 18-25 Gauge Steel**
#2 Phillips Drive, Fine Thread, Black Phosphate



#6 x 1 5/8" bugle head GFBP6158

- ✦ **Drywall to 16-18 Gauge Steel**
#2 Phillips Drive, Self Drill, Clear Zinc



#6 x 1 5/8" bugle head **SDCZ6158

- ✦ **Steel to 14-18 Gauge Steel Framing**
PAMDrive, Self Drill, Clear Zinc



#10-18 x 3/4" pan head SD101834

Wood/Steel to Steel Screws

- ✦ **Wood/DensGlass to 18-25 Gauge Steel**
PAMDrive, Full Fine Thread, Sharp Point, Clear Zinc



#8 x 1 1/2" flat head SPCZ8112
 #8 x 2" flat head **SPCZ8200

- ✦ **Wood/DensGlass to 14-18 Gauge Steel**
PAMDrive, Fine Thread, Self Drill, Clear Zinc



#8 x 2" flat head **SDCZ8200

- ✦ **Wood to 12-18 Gauge Steel**
Subfloor and Trailer Floor
 ✓ACQ **PAMDrive, Self Drill with Wings, Clear Zinc**



#10 x 1 1/2" flat head **SDW10112
 #10 x 1 3/4" flat head SDW10134

- ✦ **PAMDrive**
- ✦ **Phillips Drive**
- ✦ **Copperhead Screws***
- ✓ACQ **ACQ Tolerant**
- ✦ **Miami-Dade Approved**

Check with your dealer for additional fasteners.

*Copperhead screws compatible with ACQ, CBA-A, and CA-B treated lumber

**This fastener is made to order. Lead times may vary. Consult your local dealer.



Product Offerings



STRUCTURAL WOOD SCREWS

TimberLOK

HeadLOK

LedgerLOK

ThruLOK

FlatLOK

TRIM SCREWS

TrimFast

PAMFast

FastenMaster
PRO Driven



Task specific
fasteners for
task specific
applications

PAMFast AutoFeed Screw System

InstaChaw
Installation Gun

TC-SG

Deck Color Matching Guide

Board Collection	Board Color	Cortex Products		TrapEase Products		
		Deck	Fascia	Color Match	Deck	Fascia
Trex Transcend®	Havana Gold	TSHG	50TSHG	Havana Gold	TSHG	HG
	Island Mist	TSLM	50TSLM	Island Mist	TSLM	LM
	Lava Rock	TSLR	50TSLR	Lava Rock	TSLR	LR
	Rope Swing	TSRS	50TSRS	Rope Swing	TSRS	RS
	Spiced Rum	TSSR	50TSSR	Spiced Rum	TSSR	SR
	Tiki Torch	TSTT	50TSTT	Tiki Torch	TSTT	TT
Trex Select®	Saddle	SLSD	50SLSD	Saddle	SLSD	SD
	Pebble Grey	SLPB	50SLPB	Pebble Gray	SLPB	PB
	Winchester Grey	N/A	N/A	Winchester Grey	SLWG	WG
	Woodland Brown	N/A	N/A	Woodland Brown	SLWB	WB
Trex Enhance®	Coastal Bluff	ENCB	50ENCB	Spiced Rum	TSSR	SR
	Foggy Wharf	ENFW	50ENFW	Pebble Gray	SLPB	PB
	Rocky Harbor	ENRH	50ENRH	Rocky Harbor	TSGP	GP
	Toasted Sand	ENTS	50ENTS	Saddle	SLSD	SD
	Beach Dune	ENBD	50ENBD	Beach Dune	ENBD	BD
	Clam Shell	ENCS	50ENCS	Clam Shell	ENCS	CS
	Saddle	ENSD	50ENSD	Saddle	SLSD	SD
	Honey Grove	ENHY	50ENHY	Rope Swing	TSRS	RS
	Tide Pool	ENTP	50ENTP	Rocky Harbor	TSGP	GP
	Cinnamon Cove	ENCC	50ENCC	Lava Rock	TSLR	LR
Trex Signature®	Ocracoke	SGCK	50SGCK	Tiki Torch	TSTT	TT
	Whidbey	SGWD	50SGWD	Clam Shell	ENCS	CS
Trex® Transcend Lineage™	Island Mist	LNLM	50LNLM	Island Mist	TSLM	LM
	Biscayne	TSBC	50TSBC	Rocky Harbor	TSGP	GP
	Rainier	TSRN	50TSRN	Pebble	SLPB	PB
	Carmel	TSCM	50TSCM	Rope Swing	TSRS	RS
	Jasper	TSJP	50TSJP	Saddle	SLSD	SD
	Salt Flat	LNSF	50LNSF	Rope Swing	TSRS	RS
	Hatteras	LNHT	50LNHT	Spiced Rum	TSSR	SR
TrapEase 3 Fascia also available in White		N/A	N/A	White	N/A	WH

New board colors are always being added to the Cortex product lines. If the board color you are looking for is not listed, consult our website for recent updates or call FastenMaster customer service.



Scan QR Code to view a list of all board and color offerings

Deck and Trim *Product Numbers*

Collated Cortex Decking Kits				
Screw Material	Board Type	Packaging Qty	Coverage	SKU
Carbon Steel	Trex Enhance®, Select®, Transcend®, Signature™, Transcend® Lineage™	224 screws, 240 plugs, 2 setting tools	100 LF	FMCTXCLTX1LF****
	Trex Select®, Transcend®, Signature™, Transcend® Lineage™	1050 screws, 1200 plugs, 6 setting tools	300 SQFT	FMCTXCLTX300****

**Selecting SKU/Board Color



Cortex Screws Only				
Screw Packs	Length	SKU	Coverage	Packaging Quantity
316 Stainless Steel	2-1/2"	FMCTX212SS316-350	100 SF	350 screws, 1 setting tool
Driller	1-5/8"	FMCTXD-100NP		



Collated Cortex Plugs Only	
SKU	Packaging Quantity
FMCTXQUAD-400****	400 plugs, 1 setting tool

****Selecting SKU/Board Color



Cortex FASCIA Selection Guide				
Length	Board Type	Packaging Quantity	Coverage	SKU
1-3/4"	Trex Enhance®, Select®, Transcend®, Signature™, Transcend® Lineage™	100 screws, 105 plugs, 1 counterbore tool, 1 setting tool	50 LF	FMCTXF-TX50****

****Selecting SKU/Board Color

TrapEase FASCIA Selection Guide			
Length	Packaging Qty	Coverage	SKU
1-3/4"	200 Screws, 1 Counterbore Tool, 1 Driver Bit	100 LF	FMTRF-1LF**

**Selecting SKU/Board Color



****When ordering, combine SKU column with deck color match guide on page 50.

Deck and Trim *Product Numbers*

Cortex Trim Selection Guide						
			2" Fastener		2-3/4" Fastener	
Board	Color	Coverage	Loose Plugs	Collated Plugs	Loose Plugs	Collated Plugs
Versatex	SM = Smooth TR = Timber Ridge	50 LF	FMCTXT-VT50**	N/A	FMCTXT234-VT50**	N/A
		250 LF	FMCTXT-VT250**	FMCTXTCL-VT250**	FMCTXT234-VT250**	FMCTXTCL234-VT2**
		750 LF	FMCTXT-VT750**	FMCTXTCL-VT750**	FMCTXT234-VT750**	FMCTXTCL234-VT7**
Royal	SM = Smooth GN = Grain	50 LF	FMCTXT-RY50**	N/A	FMCTXT234-RY50**	N/A
		250 LF	FMCTXT-RY250**	FMCTXTCL-RY250**	FMCTXT234-RY250**	FMCTXTCL234-RY250**
		750 LF	FMCTXT-RY750**	FMCTXTCL-RY750**	FMCTXT234-RY750**	FMCTXTCL234-RY750**
Royal Select		250 LF	N/A	N/A	N/A	FMCTXTCL234-C2**
FT = Frost CN = Chestnut GV = Grove CL = Coastline MP = Imperial Red LT = Latte NA = Oceana WL = Willow CS = Castlestone TL = Timberland WR = Wrought Iron PB = Pine Brook SL = Shale RR = River Rock DP = Deep Pewter						
Boral	SM = Smooth GN = Grain	50 LF	FMCTXT-BR50TE**	N/A	FMCTXT234-BR50TE**	N/A
		250 LF	FMCTXT-BR250TE**	N/A	FMCTXT234-BR250TE**	N/A
		750 LF	FMCTXT-BR750TE**	N/A	FMCTXT234-BR750TE**	N/A
Cortex #20 TORX® tTap® driver bits (2 Pack of Setting Tools)						FMCTXSETTOOL3-2PK

**Selecting SKU/Board Color
 When ordering, please combine SKU column with board manufacturer color key on page 50.
 Example: Cortex 250 LF fastener length 2-3/4" for Versatex Smooth = FMCTXT234-VT250SM



Cortex Trim Replacement Plugs Selection Guide			
Board	Type	Description	SKU
Versatex®	Smooth	40pc collated replacement plugs	FMCTXTQUAD-VT40SM
	Timber Ridge		FMCTXTQUAD-VT40TR
Royal	Smooth	40pc collated replacement plugs	FMCTXTQUAD-RY40SM

New board colors are always being added to the Cortex product line. If the board color you are looking for is not listed on this page, consult our website for recent updates or call FastenMaster customer service.

TrapEase 3					
Length	Material	Quantity	Description	Coverage	SKU
2-1/2"	Carbon Steel	75pc box	75 screws, 1 bit	20 SQFT	FMTR3-212-75****
		350pc bucket	350 screws, 3 bits	100 SQFT	FMTR3-212-350****
		1050pc bucket	1050 screws, 6 bits	300 SQFT	FMTR3-212-1050****
	316 Stainless Steel	350pc bucket	Light Gray (LGSS) Light Brown (LBSS)	Dark Gray (DGSS) Dark Brown (DBSS)	FMTR3-212-350****



***Selecting SKU/Board Color
 When ordering, combine SKU column with Trex color match guide on page 50. Example: Trex Select 350pc Pebble = FMTR3-212-350SLPB
 3" also available for Trex Select® 350pc and 1050pc in: SLMD, SLPB, SLSD, SLWB

Deck and Trim *Product Numbers*

Tiger Claw Clips and Fasteners

Description	Coverage	Length	SKU
Tiger Claw TC-G 90pc Bag (for hand driving clips)	50 SQFT	1-5/8"	F-4058-TCGS
Tiger Claw TC-G Bulk Gun Pail (scrail not included)*	500 SQFT	N/A	F-5913-GNFS
Tiger Claw Scrail - Carbon Steel*	500 SQFT	1-1/2"	F-5906-GNSC
Tiger Claw Scrail - Stainless Steel*	500 SQFT	1-1/2"	F-6557-SSPS
Tiger Claw Butt Seam Clips	30 SQFT	1-5/8"	F-5969-TCBC



Tiger Claw Clip Installation Tools

Description	SKU
Installation Gun for use with F-5906-GNSC and F-6557-SSPS pneumatic scrails	F-5899-IGUN
TC-G Slot Cutter specifically designed to cut grooves into square edge decking	R-5206-RB3V

*For use with Tiger Claw Pneumatic Installation Gun

GuardDog SKU Selection Guide

Length	Packaging Qty	Coverage	SKU	Length	Packaging Qty	Coverage	SKU
1-5/8"	75pc box	20 SF	FMGD158-75	3"	75pc box	20 SF	FMGD003-75
	350pc box	100 SF	FMGD158-350		350pc box	100 SF	FMGD003-350
	1,750pc bucket	500 SF	FMGD158-1750		1,750pc bucket	500 SF	FMGD003-1750
2"	75pc box	20 SF	FMGD002-75	3-1/2"	75pc box	20 SF	FMGD312-75
	350pc box	100 SF	FMGD002-350		350pc box	100 SF	FMGD312-350
	1,750pc bucket	500 SF	FMGD002-1750		1,350pc bucket	350 SF	FMGD312-1350
2-1/2"	75pc box	20 SF	FMGD212-75	Driver bit for GuardDog w/ TORX Itap drive system (2 included)			FMGDTTAPT25-2PK
	350pc box	100 SF	FMGD212-350				
	1,750pc bucket	500 SF	FMGD212-1750				

*Coverage based on 16" o.c. joist spacing and 5-1/2" wide decking



Structural Wood Fasteners *Product Numbers*

FastenMaster MVP SKU Selection Guide		
Length	Packaging Qty	SKU
1-1/2"	100 Pack	FMMVP112-100
	500 Pack	FMMVP112-500
	2000 Pack	FMMVP112-2000
2"	100 Pack	FMMVP002-100
	500 Pack	FMMVP002-500
	2000 Pack	FMMVP002-2000
2-1/2"	100 Pack	FMMVP212-100
	450 Pack	FMMVP212-450
	2000 Pack	FMMVP212-2000
3"	100 Pack	FMMVP003-100
	350 Pack	FMMVP003-350
	1600 Pack	FMMVP003-1600
3-1/2"	100 Pack	FMMVP312-100
	250 Pack	FMMVP312-250
	1250 Pack	FMMVP312-1250
4"	100 Pack	FMMVP004-100
	250 Pack	FMMVP004-250
	1250 Pack	FMMVP004-1250

TimberLOK SKU Selection Guide		
Length	Packaging Qty	SKU
2-1/2"	Single fastener	FMTLOK212-INDY
	12pc clamshell	FMTLOK212-12
	50pc box	FMTLOK212-50
	500pc bucket	FMTLOK212-500
4"	Single fastener	FMTLOK04-INDY
	12pc clamshell	FMTLOK04-12
	50pc box	FMTLOK04-50
	250pc bucket	FMTLOK04-250
6"	Single fastener	FMTLOK04-INDY
	12pc clamshell	FMTLOK06-12
	50pc box	FMTLOK06-50
	250pc bucket	FMTLOK06-250
8"	Single fastener	FMTLOK08-INDY
	12pc clamshell	FMTLOK08-12
	50pc box	FMTLOK08-50A
	250pc bucket	FMTLOK08-250
10"	Single fastener	FMTLOK10-INDY
	12pc clamshell	FMTLOK10-12
	50pc box	FMTLOK10-50A
	250pc box	FMTLOK10-250



Structural Wood Fasteners *Product Numbers*

HeadLOK Standard Selection Guide		
Length	Packaging Qty	SKU
2-7/8"	Single fastener	FMHLGMITT278-INDY
	12pc clamshell	FMHLGMITT278-12
	50pc box	FMHLGMITT278-50
	500pc bucket	FMHLGMITT278-500
4-1/2"	Single fastener	FMHLGMITT412-INDY
	12pc clamshell	FMHLGMITT412-12
	50pc box	FMHLGMITT412-50
	250pc bucket	FMHLGMITT412-250
6"	Single fastener	FMHLGMITT006-INDY
	12pc clamshell	FMHLGMITT006-12
	50pc box	FMHLGMITT006-50
	250pc bucket	FMHLGMITT006-250
8"	Single fastener	FMHLGMITT008-INDY
	12pc clamshell	FMHLGMITT008-12
	50pc box	FMHLGMITT008-50
	250pc bucket	FMHLGMITT008-250
10"	Single fastener	FMHLGMITT010-INDY
	12pc clamshell	FMHLGMITT010-12
	50pc box	FMHLGMITT010-50
	250pc bucket	FMHLGMITT010-250

Additional Length Selection Guide		
Length	Packaging Qty	SKU
3-3/4"	50pc bucket	FMHLGMITT334-50
	250pc bucket	FMHLGMITT334-250
5"	250pc bucket	FMHLGMITT005-250
7"	250pc bucket	FMHLGMITT007-250
8"	250pc bucket	FMHLGMITT008-250
9"	250pc bucket	FMHLGMITT009-250
10"	250pc bucket	FMHLGMITT010-250
11"	250pc bucket	FMHLGMITT011-250
12"	250pc bucket	FMHLGMITT012-250
13"	250pc clamshell	FMHLGMITT013-250
14"	250pc bucket	FMHLGMITT014-250

HeadLOK TORX ttap Bits	
2 TORX® ttap® bits per card	FMTTAPT30BIT-2PK



Structural Wood Fasteners *Product Numbers*

LedgerLOK SKU Selection Guide			
Length	Packaging Qty	Hex Style SKU	Flathead SKU
3-5/8"	Single Fastener	FMLL358-INDY	FMLLF358-12INDY
	12pc clamshell	FMLL358-12	FMLLF358-12
	50pc box	FMLL358-50	FMLLF358-50
	250pc bucket	FMLL358B-250	FMLLF358B-250
5"	Single Fastener	FMLL005-INDY	FMLLF005-INDY
	12pc clamshell	FMLL005-12	FMLLF005-12
	50pc box	FMLL005-50	FMLLF005-50
	250pc bucket	FMLL005B-250	FMLLF005B-250



ThruLOK SKU Selection Guide			
Length	Wood Dim Range	Pkg Qty	SKU
6-1/4"	4-1/2" to 5-1/4"	Single Fastener	FMTHR614-INDY
		24pc box	FMTHR614-24
7"	5-1/4" to 6"	Single Fastener	FMTHR007-INDY
		24pc box	FMTHR007-24
8"	6-1/4" to 7"	Single Fastener	FMTHR008-INDY
		24pc box	FMTHR008-24
9-1/2"	7-3/4" to 8-1/2"	Single Fastener	FMTHR912INDY



VersaLOK SKU Selection Guide		
Length	Pkg Qty	SKU
6"	Single Fastener	FMVL006-INDY
	50pc box	FMVL006-50
8"	Single Fastener	FMVL008-INDY
	50pc box	FMVL008-50
10"	Single Fastener	FMVL010-INDY
	50pc box	FMVL010-50

Structural Wood Fasteners *Product Numbers*

FlatLOK SKU Selection Guide			
Length	Typical Applications	Packaging Qty	SKU
2-7/8"	2-Ply Roof Girder Trusses	50pc box	FMFL278-50
		500pc bucket	FMFL278B-500
3-1/2"	2-Ply LVL Beams	Single fastener	FMFL312-INDY
		50pc box	FMFL312-50
		250pc bucket	FMFL312B-250
4"	Interior Corridor Ledgers	50pc box	FMFL004-50
		250pc bucket	FMFL004B-250
4-1/2"	3-Ply Roof Girder Trusses	50pc box	FMFL412-50
		250pc bucket	FMFL412B-250
5"	3-Ply LVL Beams	Single fastener	FMFL005-INDY
		50pc box	FMFL005-50
		250pc bucket	FMFL005B-250
6"	4-Ply Roof Girder Trusses	50pc box	FMFL006-50
		250pc bucket	FMFL006B-250
6-3/4"	4-Ply LVL Beams	Single fastener	FMFL634-INDY
		50pc box	FMFL634-50
		200pc bucket	FMFL634B-200



OlyLog SKU Selection Guide		
Length	Qty	SKU
2-1/2"	500pc box	LOG212
4"	250pc box	LOG004
6"	250pc box	LOG006
8"	250pc box	LOG008
9"	250pc box	LOG009
10"	250pc box	LOG010
12"	250pc box	LOG012
14"	250pc box	LOG014
16"	250pc box	LOG016



LogHog SKU Selection Guide		
Length	Qty	SKU
7"	250pc box	LHOG007
9"	250pc box	LHOG009
10"	250pc box	LHOG010
11"	250pc box	LHOG011
12"	250pc box	LHOG012
13"	250pc box	LHOG013
15"	150pc box	LHOG015

Wood Framing Systems *Product Numbers*

FrameFAST Product Offerings					
Fastener		Tools		Additional Heads	
Description	SKU	Tool Description	SKU	Head Description	SKU
NEW 50 pc. box w/TORX ttap 2" drive bit	FMFFTT006-50	FF Cordless Milwaukee	FMFFTOOLT2TP-MILC	Truss to Top Plate Head	FMFFHEAD-T2TP
		FF Cordless DeWALT	FMFFTOOLT2TP-DWC	Stud to Plate Head	FMFFHEAD-S2P
250 pc. Bucket w/TORX ttap 2" & 6" drive bit	FMFFTT006B-250			Plate to Rim Head	FMFFHEAD-P2R

All FrameFAST Tools include (2) replacement TORX® ttap® drive bits and the FrameFAST Truss-to-Top-Plate head. Cordless tools do not include battery or charger.



PAMFast Product Offerings		
SKU	Compatible Motor	Power Type
SD-20-DWC13KUE*	DeWALT DCF622B	Cordless
SD-20-MAC13KUE*	Makita XSF04Z	Cordless
SD-20-DW13KUE	DeWALT DW268	Corded
SD-20-DWC13KIT**	DeWALT DCF622B	Cordless
D-20-MAC13KIT**	Makita XSF04Z	Cordless



*Batteries/charger sold separate **Kit only (no screw gun)

See PAMFast AutoFeed Screw listings on page 51-52



NLB Connector SKU Selection Guide	
Description	SKU
NLB Connector (50 pack)	FMNLB006-50



Lateral Tension System Selection Guide	
Contents	SKU
(4) Lateral Tension Brackets, (4) Transfer Screws, (32) Bracket Mounting Screws, (2) Driver Bits	FMLTS-4

Delivering PRO Driven Service Nationwide



Hands-on Jobsite Support for PROs

By offering hands-on product training, on-site technical support, and tailored solutions, we aim to establish a strong partnership with PRO contractors. We understand the unique challenges faced by contractors and aim to provide the necessary support and resources to help them succeed on their jobsites.



Dealer Training and Merchandising

We strive to establish valuable partnerships with our retail partners by offering comprehensive support via our dedicated field sales team such as on-site product training and dynamic merchandising setups. Our strong relationships with PRO contractors helps our dealers to maximize their sales potential and deliver a positive customer experience.



New Construction Engineering Team

Our engineering team is committed to providing unparalleled support to building designers and engineers, offering direct assistance and technical expertise. Plus, our Building Connections field team collaborates closely throughout the entire design and construction process to facilitate successful project execution.



FMFULCAT (0325)

How to Connect with FastenMaster

- Call us:** 800-518-3569
- Email us:** info@fastenmaster.com
- Follow us:** [@fastenmasterpro](https://www.instagram.com/fastenmasterpro)
- Visit us:** [fastenmaster.com](https://www.fastenmaster.com)

Scan to contact your local representative here:

